



CATÁLOGO DE
PRODUCTOS

2021



NOSOTROS



CONOCIMIENTO DEL PRODUCTO

Un equipo humano altamente cualificado responderá a todas las dudas técnicas que te puedan surgir. Del mismo modo, nuestro departamento de desarrollo queda a tu disposición para valorar la posibilidad de fabricar aquellos elementos que puedas necesitar.



NUNCA VENDERÁS SOLO

Nuestra misión no se limita a la comercialización de nuestros productos: ofrecemos tanto un buen asesoramiento previo, como nuestro mejor servicio post-venta. En definitiva, dedicamos tanto tiempo en atender a nuestros clientes, como en ayudar a nuestros distribuidores y socios con estrategias de venta y planes de marketing.



GRAN STOCK DE PIEZAS

Cientos de referencias en stock para poder dar siempre el mejor resultado, indiferentemente del volumen del pedido. Nuestros almacenes están diseñados con el objetivo de que ningún cliente tenga que detenerse por la demora en la entrega de un recambio.



CALIDAD COMO CUALIDAD

Este es el principio sobre el que construimos todo lo demás, dado que trabajamos día a día con un elemento de seguridad básico en la automoción e industria. Nuestros componentes son producidos bajo los más altos estándares de calidad fijados por los fabricantes.



PRECIO HONESTO

Queremos garantizarte que siempre proporcionaremos todos nuestros repuestos a precios competitivos, aplicando los mejores descuentos que podamos. Para conseguirlo, buscamos la eficiencia en todos nuestros proyectos, además de negociar arduamente con nuestros proveedores.



COMPROMISO EN CADA ENVÍO

Estamos continuamente actualizando nuestros procesos de almacén y logística. Preparando cualquier pedido en el transcurso del día. Nuestra implicación con el cliente nos lleva a negociar con las agencias de transporte, logrando así ofrecer el mayor tiempo posible para ti y tus clientes.





Nuestro inicio fue hace ya medio siglo, como un pequeño taller que se dedicaba a todo lo relacionado con la fricción e hidráulica para la automoción: **éramos freneros.**

En muchas ocasiones dedicábamos excesivo tiempo para localizar una pieza, con la complicación añadida que debía de ser con un paso de rosca concreto.

Todas esas horas de incesantes búsquedas dieron como resultado uno de **los catálogos más completos del mercado**, convirtiéndonos en el proveedor global de canalizaciones hidráulicas y neumáticas del sistema de freno, **Gomas y Equipos de Reparación (GOER)**. Por lo que nos hemos comprometido desde el inicio a desarrollar una oferta completa de racorería, proporcionándole tuberías, adaptadores, conexiones, racores, purgadores... todos ellos equipos de **alta calidad**.

<https://www.goer.es>



ÍNDICE

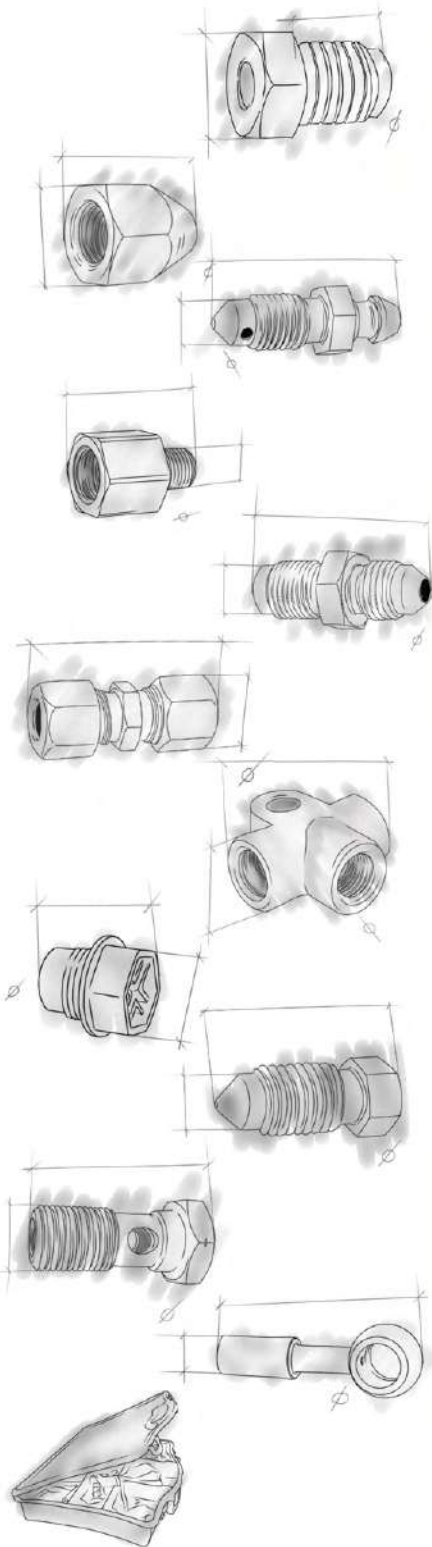

RM	RACOR MACHO	- - - -	7
RH	RACOR HEMBRA	- - - -	15
RS	RACOR SANGRADOR	- - -	19
RR	RACOR REDUCTOR	- - -	25
RC	RACOR CONECTOR	- - -	31
RE	RACOR EMPALME	- - - -	33
RT	RACOR TEE	- - - -	35
RP	RACOR PROTECTOR	- - -	37
RA	RACOR ANULADOR	- - -	39
RB	RACOR BANJO	- - - -	43
RJ	RACOR OJAL	- - - -	47
RK	KIT RACORES	- - - -	51

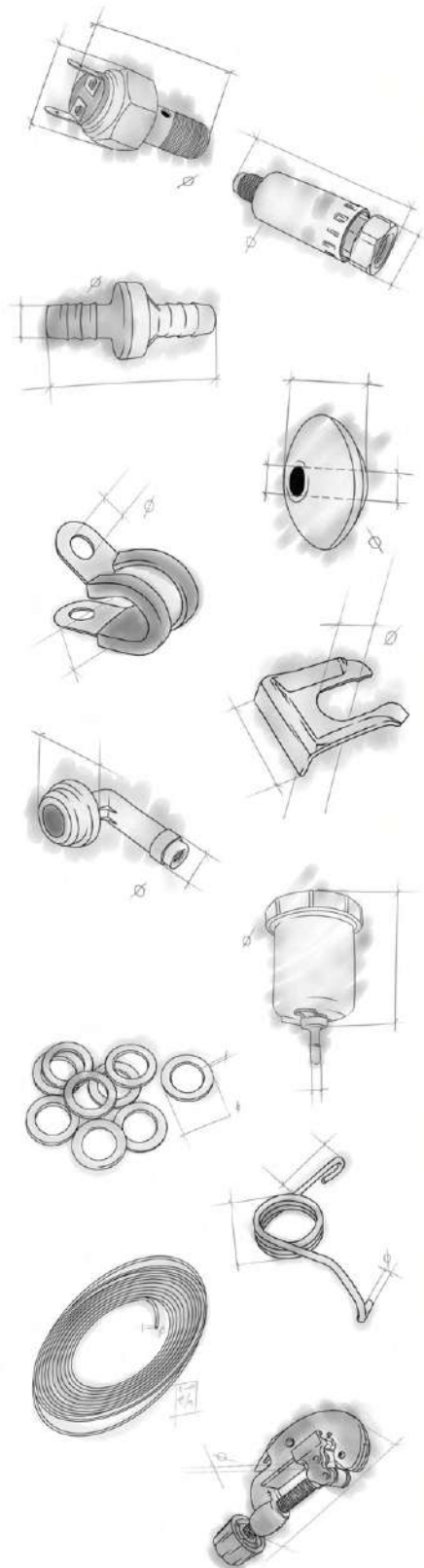

HF	HIDROSTOP FRENO	— — — —	57
VF	VÁLVULA FRENO	— — — —	59
SF	SERVO FRENO	— — — —	61
LF	LENTEJA FRENO	— — — —	63
GF	GRAPA FRENO	— — — —	65
CF	CIRCLIP FRENO	— — — —	69
PF	PIPA FRENO	— — — —	73
DF	DEPÓSITO FRENO	— — — —	75
AF	ARANDELA FRENO	— — — —	77
MF	MUELLES FRENO	— — — —	79
TF	TUBERÍAS FRENO	— — — —	89
UF	UTILLAJE FRENO	— — —	91
	ÍNDICE DE REFERENCIAS	— — —	105

RM RACOR MACHO



En nuestro catalogo encontraras una gran variedad de pasos de rosca whitworth y métrica con los que satisfacer todas las necesidades de línea de freno. Nuestros racores siguen los estándares de fabricación que fija OEM, de tal modo estamos seguros que siempre encontraras un racor idéntico al que retires.

Queremos ofrecerte el mejor precio posible en nuestros racores, por ello al comprar 10 unidades de la misma referencia accederas a un precio especial (añade una X al final de cada referencia, por ejemplo: RM0120X).











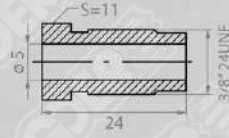

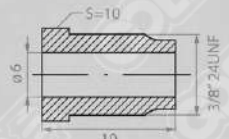

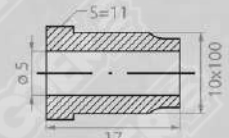

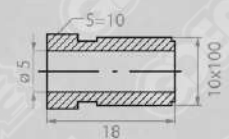

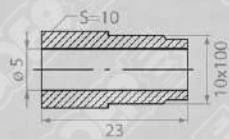

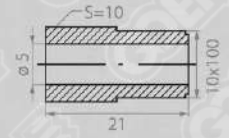

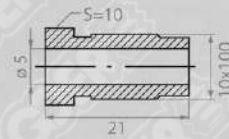
Imagen	Cota	Ø	Ref.	Rosca
		3,70	RM0120	8x125
		4,70	RM0160	9x125
		4,95	RM0166	3/8x24
		4,95	RM0167	
		5,00	RM0109	
		5,00	RM0115	
		5,00	RM0117	
		5,00	RM0168	

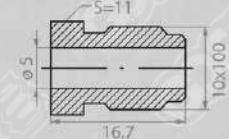
RM RACOR MACHO

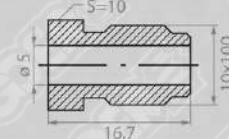
Rosca Ref. Ø Cota Imagen

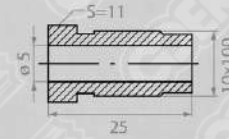
3/8x24

Rosca	Ref.	Ø	Cota	Imagen
3/8x24	RM9150	5,00		
3/8x24	RM5007	6,00		
10x100	RM0105	5,00		
10x100	RM0116	5,00		
10x100	RM0205	5,00		
10x100	RM0216	5,00		
10x100	RM0405	5,00		
10x100	RM0505	5,00		
10x100	RM0605	5,00		
10x100	RM9620	5,00		

10x100

Imagen	Cota	Ø	Ref.	Rosca
		6,00	RM5006	10x100
		6,00	RM6408	
		5,00	RM0112	10x125
		5,00	RM0113	
		6,00	RM6410	
		4,75	RM7188	10x150
		5,00	RM0114	7/16x20
		6,50	RM0214	
		6,50	RM0170	
		6,50	RM0270	

RM RACOR MACHO

Rosca Ref. Ø Cota Imagen

7/16X24

RM0169

4,95

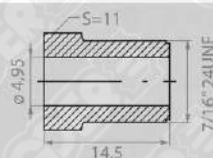

RM0414

5,20

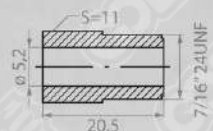

RM0172

6,50

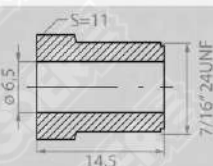

RM0104

5,00

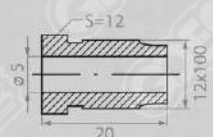

RM0118

5,00

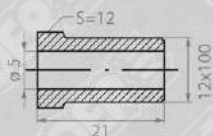

RM0204

5,00

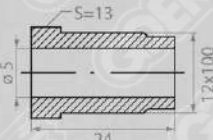

12X100

RM0119

6,00

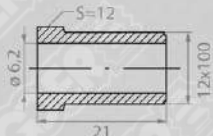

RM0202

6,20

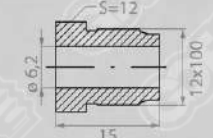

RM0102

6,20

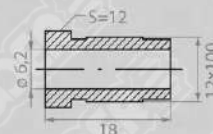

RM0103

6,50











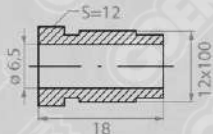

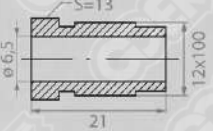

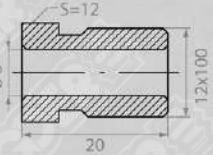

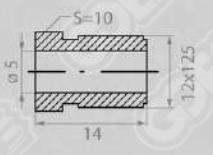

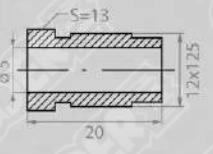

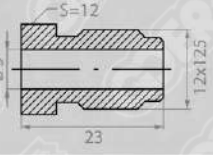

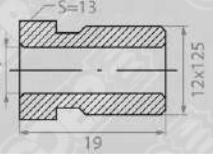
Imagen	Cota	Ø	Ref.	Rosca
		6,50	RM0303	12x100
		8,00	RM9282	
		5,00	RM4130	
		5,00	RM4145	12x125
		5,00	RM9040	
		6,50	RM0161	
		6,50	RM0203	12x150
		4,75	RM7193	
		6,00	RM8005	
		5,00	RM9550	1/2x20

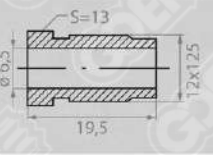
12x100

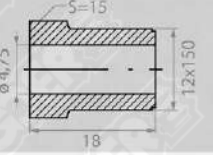
12x125

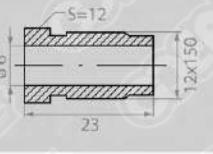
12x150

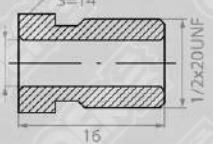
1/2x20

RM RACOR MACHO

Rosca Ref. Ø Cota Imagen

1/2x20

RM4175

5,00

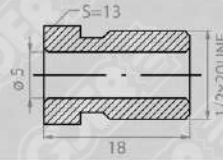

RM6157

6,00

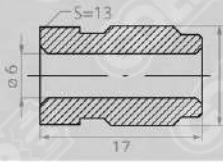

RM4176

6,50

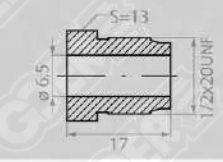

RM4174

8,00

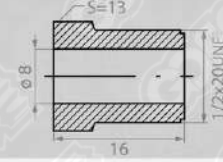

RM8009

8,00

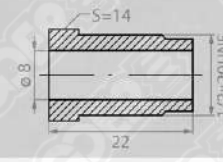

1/4 BSPP

RM0173

4,95

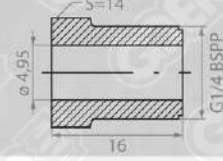

RM0174

4,95

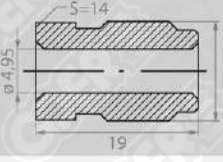

9/16x18

RM0171

5,50

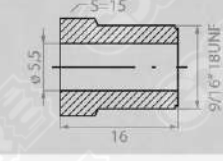

RM0271

6,50

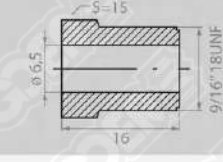

14x100

RM0162

6,50



Imagen	Cota	Ø	Ref.	Rosca
		8,20	RM4262	14x100
		6,50	RM0163	14x125
		8,30	RM0131	14x150
		8,30	RM0164	14x150
		10,20	RM4265	5/8x18UNF
		10,60	RM4264	16x150
		8,00	RM7198	16x150
		8,00	RM7199	18x150

RH RACOR HEMBRA

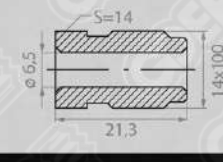

Nuestros terminales hembra de la línea de freno, también denominados tuercas de tubo o simplemente racores, son contruidos, al igual que el resto de categorías, siguiendo los estándares fijados por origen.

Queremos ofrecerte el mejor precio posible en nuestros racores, por ello al comprar 10 unidades de la misma referencia accederás a un precio especial (añade una X al final de cada referencia, por ejemplo: RH0111X).



Imagen	Cota	Ø	Ref.	Rosca
		5,00	RH0111	3/8x24
		5,00	RH0110	
		6,00	RH5010	10x100
		5,00	RH0106	
		5,00	RH0108	
		5,00	RH0408	
		5,00	RH0210	
		6,00	RH5102	



3/8x24

10x100

RH RACOR HEMERA

Diámetro Ref. Ø Cota Imagen

1/2" (12,7)

RH-RAC33	3,00		
----------	------	---	---

3/4" (19,0)

RH-RAC34	4,00		
----------	------	---	---

1" (25,4)

RH-RAC35	5,00		
----------	------	---	---

RH-RAC36	6,35		
----------	------	--	--

1 1/4" (31,8)

RH-RAC37	7,94		
----------	------	---	---

RH-RAC38	9,50		
----------	------	---	---

1 1/2" (38,1)

RH-RAC39	12,00		
----------	-------	---	---

RH-RAC40	15,88		
----------	-------	---	---

2" (50,8)

RH-RAC41	20,00		
----------	-------	---	---

RH-RAC42	25,40		
----------	-------	---	---

Imagen	Cota	Ø	Ref.	Rosca
		10,30	RH4269	16x150

TIPS

Es importante saber que el punto crítico de casi todas las conexiones de freno y embrague es el asiento. Al igual que los tornillos banjos hacen el cierre a través de la arandela, en este caso el cierre lo proporciona el tipo de abocardado que realicemos, por ello es muy importante saber identificar los tipos que existen.

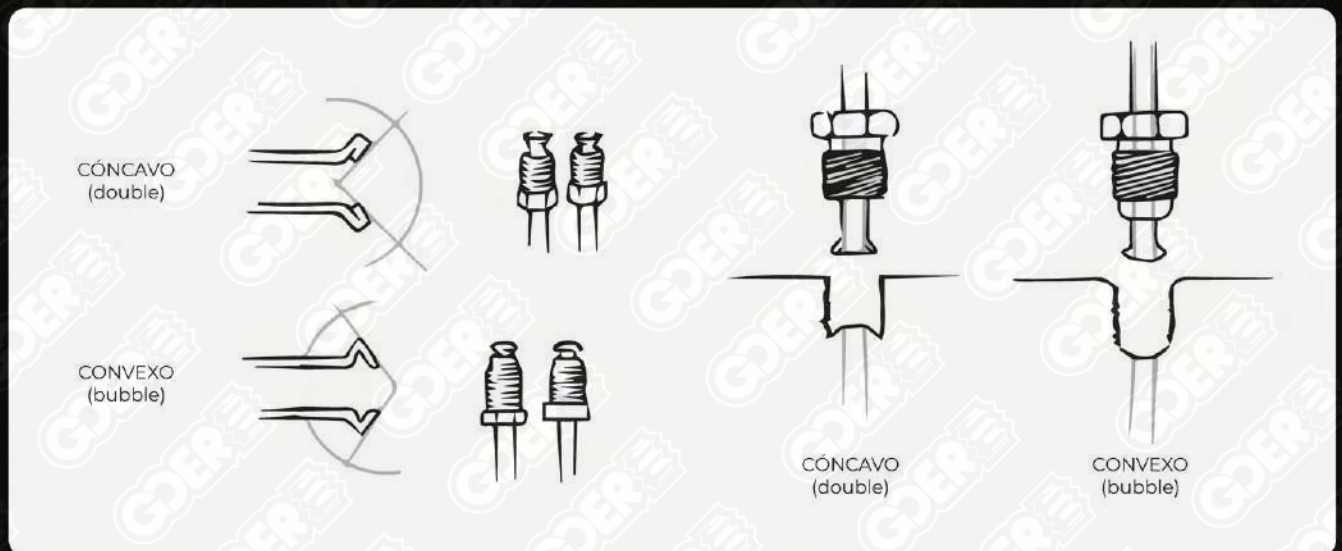

Los más comunes son cóncavo (SAE o Double) o bien convexo (DIN o Bubble). Éstos son comúnmente los más utilizados, pero también hay otros, como tal vez sólo el conocido por los más nostálgicos, donde Citroën realizaba un abocardado retardado a escasos centímetros del comienzo de la tubería ayudándose para el cierre de un retén de forma cilíndrica.

RS RACOR SANGRADOR



Los tornillos de purga son uno de los puntos más débiles de cualquier vehículo. Si alguna vez se ha partido un sangrador de freno oxidado o se ha pasado la llave, probablemente comprendas el valor de tener un par de ellos a mano. Nuestros sangradores de freno siguen los estándares que fija OEM: podrás observar fácilmente que tenemos siempre un sangrador de freno igual o equivalente al que retires del vehículo.

Queremos ofrecerte el mejor precio posible en nuestros racores, por ello al comprar 10 unidades de la misma referencia accederás a un precio especial (añade una X al final de cada referencia, por ejemplo: RS0013X).



Imagen	Cota	Ref.	Rosca
		RS0013	6x100
		RS0033	
		RS0120	
		RS0220	1/4x28
		RS0105	
		RS0053	7x100
		RS0253	
		RS0069	

6x100

1/4x28

7x100

Rosca Ref. Cota Imagen

7x100

RS0086

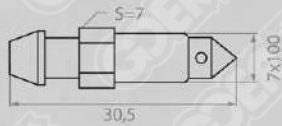

RS0087



RS0088

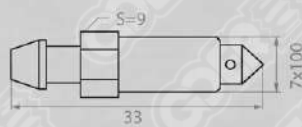

RS0094



RS5808

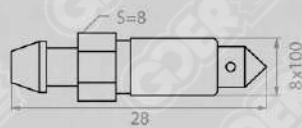

RS0089

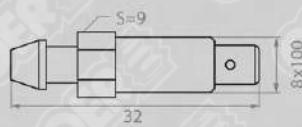

RS0090

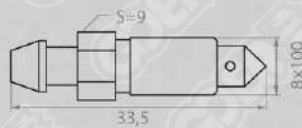

RS0091

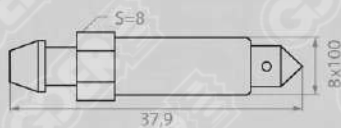

RS0085

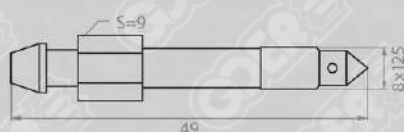

RS0010

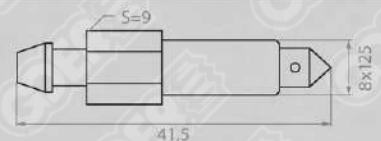











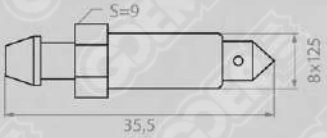
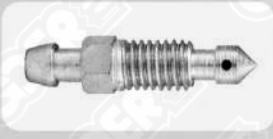
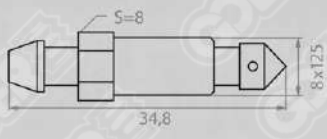

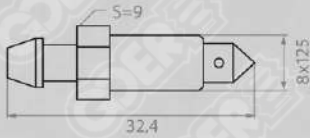

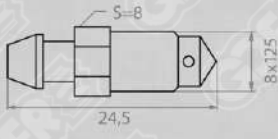

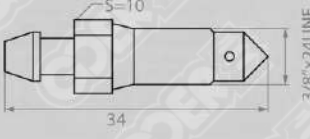
8x125

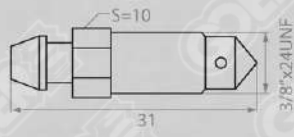
Imagen

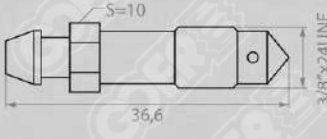
Cota

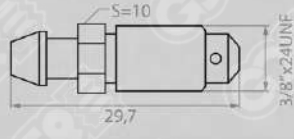
Ref.

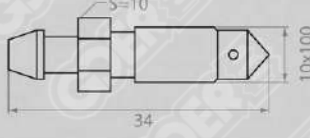
Rosca

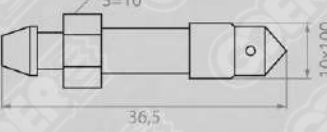
		RS0011	8x125
		RS0092	
		RS0015	
		RS0100	
		RS0049	
		RS0107	
		RS0108	
		RS0132	
		RS0017	10x100
		RS0018	

8x125

3/8x24

10x100

RS RACOR SANGRADOR

Rosca Ref. Cota Imagen

10x100

RS0019

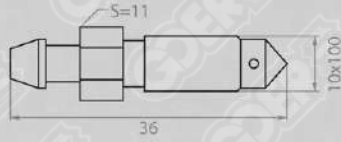

RS0039

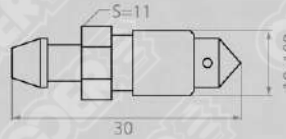

RS0131

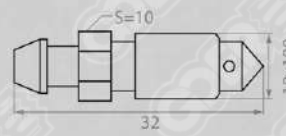

RS5006

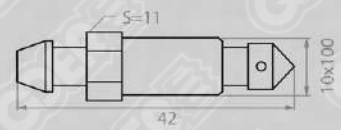

10x125

RS0101

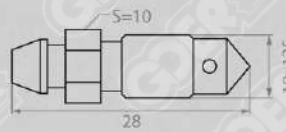

RS0103

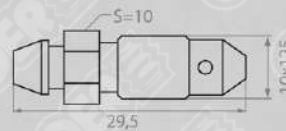

10x150

RS4123

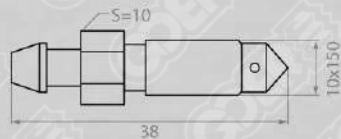

7/16x20

RS9200

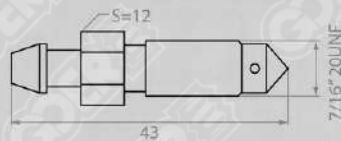

7/16x24

RS8817

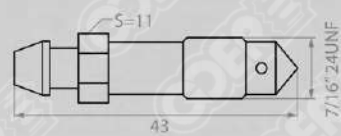

12x100

RS0040



Imagen	Cota	Ref.	Rosca
		RS9540	12x100
		RS9040	
		RS9810	12x125
		RS9501	12x150

TIPS

Nuestros protectores o capuchones son unos guardapolvos especialmente diseñados para el sangrador de freno y que multiplican por diez su tiempo de vida.

Teniendo unos cuantos a mano podrás dar un valor añadido a tus reparaciones.

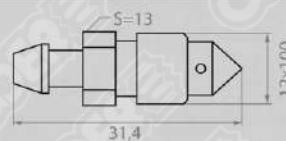
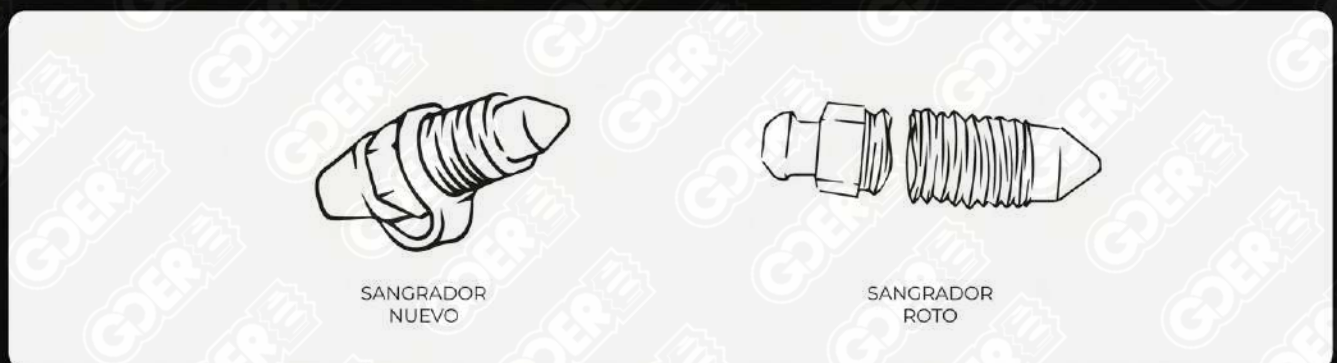

Normalmente los sangradores de rosca americana suelen necesitar de una llave especial, ya que el hexágono está en medida fraccionada. Para solucionar este problema y siendo consciente de que nuestro mercado es el europeo, te ofrecemos el mismo paso de rosca en el racor pero con una llave de hexágono clásica (en métrica).

RR RACOR REDUCTOR



Estamos seguros de que en muchas ocasiones te ha ocurrido que esa bomba de freno o bombín que tienes en tu almacén si fuese de 12x100 en lugar de 10x100 le podrías dar salida. Sea o no ese el motivo y esa u otra la rosca, nuestro amplio y cuidado catálogo de estos pequeños salvavidas te ayudarán a continuar con tu venta o reparación.

Queremos ofrecerte el mejor precio posible en nuestros racores, por ello al comprar 5 unidades de la misma referencia accederás a un precio especial (añade una V al final de cada referencia, por ejemplo: RR9050V).



Imagen	Cota	R.Macho	R.Hembra	Ref.
		3/8x24	3/8x24	RR9682
		3/8x24	10x100	RR9680
		3/8x24	10x100	RR0231
		3/8x24	10x125	RR9681
		3/8x24	7/16x20	RR9683
		3/8x24	7/16x20	RR7045
		3/8x24	1/2x20	RR7304
		10x100	7x100	RR9050

RR RACOR REDUCTOR

Ref.	R.Macho	R.Hembra	Cota	Imagen
RR0235	10x100	8x100		
RR7049	10x100	3/8x24		
RR7125	10x100	3/8x24		
RR0135	10x100	10x100		
RR0137	10x100	10x125		
RR9243	10x100	7/16x20		
RR0232	10x100	12x100		
RR0132	10x100	12x100		
RR8114	10x100	12x100		
RR9221	10x125	3/8x24		

Imagen	Cota	R.Macho	R.Hembra	Ref.
		10x125	10x100	RR0136
		10x125	10x125	RR0138
		10x125	12x100	RR0146
		7/16x20	3/8x24	RR7047
		7/16x20	10x100	RR0230
		7/16x20	10x100	RR9670
		7/16x20	12x100	RR9671
		7/16x20	1/2x20	RR9350
		7/16x24	3/8x24	RR7046
		7/16x24	1/2x20	RR7127

RR RACOR REDUCTOR











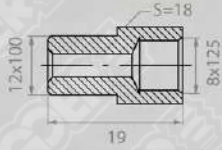

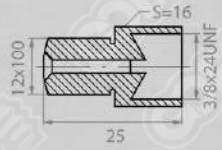

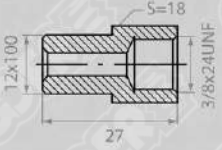

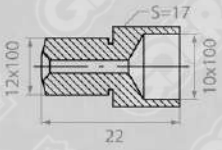

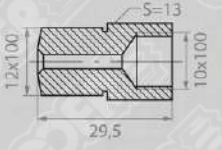

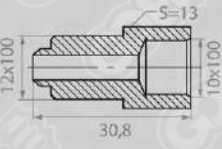

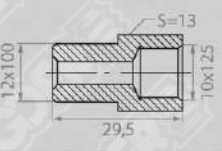

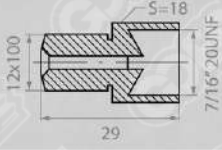

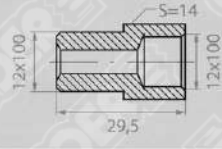

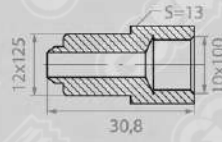

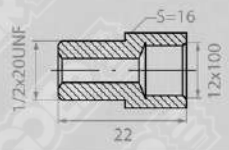

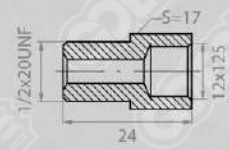

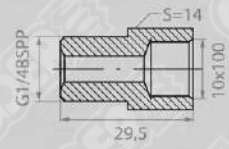

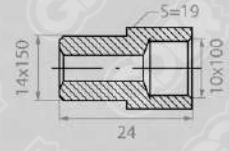

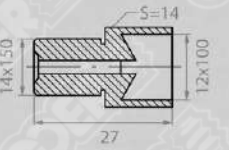
Ref.	R.Macho	R.Hembra	Cota	Imagen
RR9880	12x100	8x125		
RR7383	12x100	3/8x24		
RR9891	12x100	3/8x24		
RR0335	12x100	10x100		
RR0129	12x100	10x100		
RR0229	12x100	10x100		
RR0139	12x100	10x125		
RR9892	12x100	7/16x20		
RR0147	12x100	12x100		
RR0234	12x125	10x100		

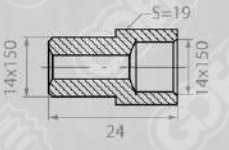
Imagen	Cota	R.Macho	R.Hembra	Ref.
		12x125	10x125	RR0144
		12x125	12x100	RR8128
		12x125	12x150	RR8129
		12x150	3/8x24	RR9472
		12x150	10x100	RR9471
		12x150	10x125	RR9470
		12x150	12x150	RR8100
		1/2x20	3/8x24	RR7300
		1/2x20	10x100	RR9310
		1/2x20	7/16x24	RR7301

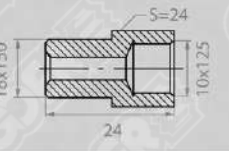
RR RACOR REDUCTOR

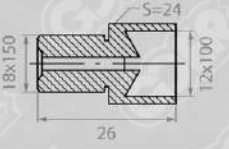
Ref.	R.Macho	R.Hembra	Cota	Imagen
RR9312	1/2x20	12x100		
RR8108	1/2x20	12x125		
RR0233	1/4BSPP	10x100		
RR8105	14x150	10x100		
RR8113	14x150	12x100		
RR8102	14x150	14x150		
RR8120	18x150	10x125		
RR8122	18x150	12x100		
RR8118	18x150	12x125		

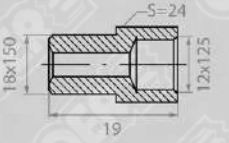
RC RACOR CONECTOR













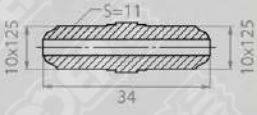

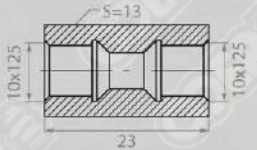

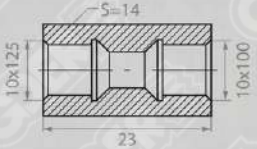

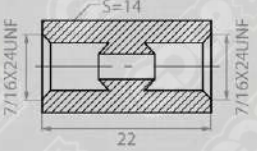

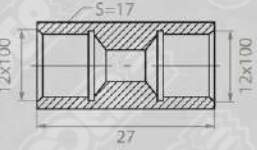
Nuestros racores de conexión hembra-hembra o macho-macho con la misma (o diferente) rosca en ambos extremos te permitirán unir aquellos terminales finales que por cualquier motivo han quedado separados: es una opción segura y rápida.

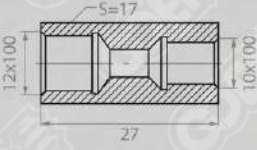
Queremos ofrecerte el mejor precio posible en nuestros racores, por ello al comprar 5 unidades de la misma referencia accederás a un precio especial (añade una V al final de cada referencia, por ejemplo: RC0134V).

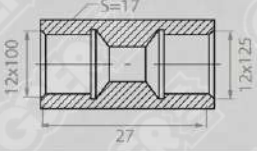

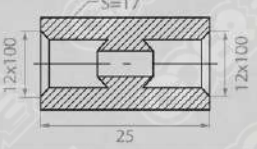
Imagen	Cota	Rosca 1	Rosca 2	Ref.
		3/8x24	3/8x24	RC0134
		3/8x24	3/8x24	RC0142
		3/8x24	3/8x24	RC0143
		10x100	10x100	RC0133
		10x100	10x100	RC0121
		10x100	10x100	RC0124
		10x100	3/8x24	RC0301
		10x100	10x100	RC0302

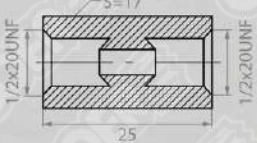
RC RACOR CONECTOR

Ref.	Rosca 1	Rosca 2	Cota	Imagen
RC0149	10x125	10x125		
RC0122	10x125	10x125		
RC0123	10x125	10x100		
RC7111	7/16x24	7/16x24		
RC0130	12x100	12x100		
RC0131	12x100	10x100		
RC0145	12x100	12x125		
RC0148	12x100	12x100		
RC7112	1/2x20	1/2x20		

RE RACOR DE EMPALME



Nuestros empalmes pueden ser útiles para salir del paso o para realizar alguna prueba. Una solución rápida que no requiere desmontar la tubería para abocardar, empalmando a ambos lados dos tuberías del mismo diámetro.

Queremos ofrecerte el mejor precio posible en nuestros racores, por ello al comprar 5 unidades de la misma referencia accederás a un precio especial (añade una V al final de cada referencia, por ejemplo: RE0151V).



Imagen	Cota	Ø	Ref.
		3,50	RE0151
		4,50	RE0152
		4,80	RE0150
		5,00	RE0156
		6,00	RE0153
		6,35	RE0154
		8,00	RE0155
		10,00	RE6860

RE RACOR DE EMPALME

Ref.	Ø	Cota	Imagen
RE6862	12,00		

TIPS

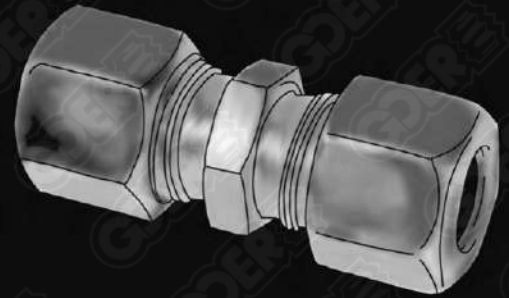
Para utilizar correctamente estos racores de empalme es importante conocerlos.

Ambos extremos de las tuberías deben de ser del mismo diámetro, en el caso de que el tubo sea de 4,75 usaremos el empalme de 4,80, y en caso de ser de 5,00 usaríamos el de 5,20.

Consta de un cuerpo con asiento para el tubo, dos anillos de compresión y una tuerca de cierre. La unión hermética del tubo al cuerpo del racor se realiza gracias a la presión ejercida por los dos anillos sobre el tubo al ser éstos presionados por la tuerca.

Para su correcto funcionamiento, el tubo deberá tener un acabado superficial liso, exento de suciedad o estrías con el fin de conseguir un perfecto ensamblaje de los dos anillos al mismo.

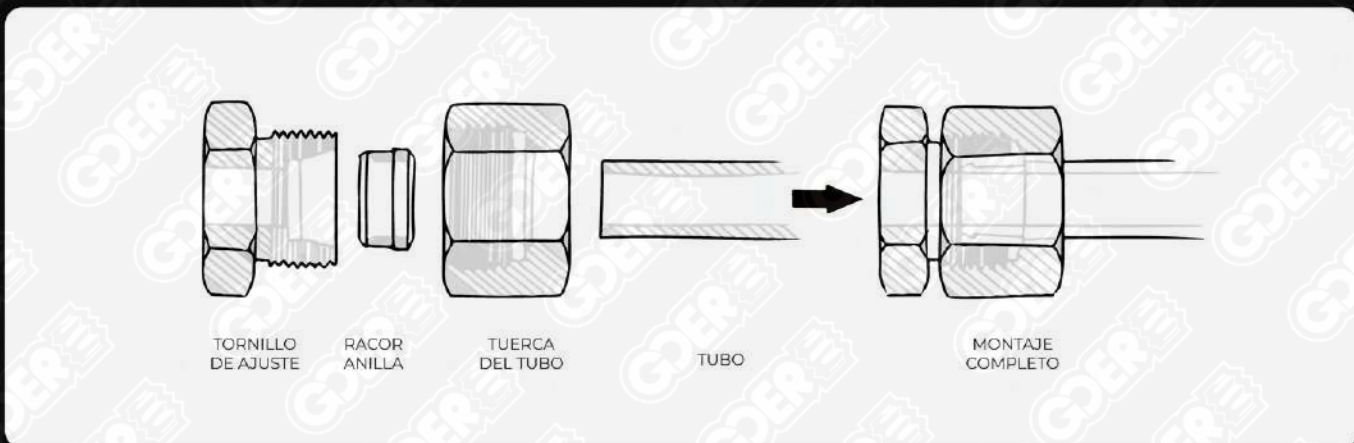

RT RACOR TEE



Estos componentes proporcionan una unión sólida para bifurcar de una a dos vías, en diferentes formatos y materiales disponibles. El producto ofrece muchas posibilidades más allá de lo que a primera vista parece, ya que te servirá por ejemplo para puentear elementos hidráulicos como repartidores de fuerza de frenado, para comprobar un sistema de freno como el ABS o simplemente para crear combinaciones con otros componentes obteniendo una salida extra.

Queremos ofrecerte el mejor precio posible en nuestras tees, por ello al comprar 5 unidades de la misma referencia accederás a un precio especial (añade una V al final de cada referencia, por ejemplo: RT0140V).



Imagen	Cota	Tipo	Ref.	Rosca
		T	RT0140	3/8x24
		T	RT0141	
		O	RT7056	
		T	RT0126	10x100
		T	RT0127	
		O	RT7091	
		O	RT7095	10x125
		T	RT0125	

3/8x24

10x100

10x125

RT RACOR TEE

Rosca Ref. Tipo Cota Imagen

7/16x20	RT7094	O		
7/16x24	RT7092	O		
12x100	RT0128	T		
12x125	RT8004	T		
10x100	RT4004	H		

TIPS

En ocasiones los vehículos tienen conectores o repartidores donde alguna de las roscas de conexión es de un paso diferente para poder identificar la postura, es decir, marcar el eje o la mano que guarda.

Cuando esto suceda puedes modificar una de esas salidas combinando un Racor Tee (RT) con un Racor Reductor (RR) o con un Racor Conector (RC).



RP RACOR PROTECTOR



Guardapolvos fabricados en caucho y otros materiales derivados del plástico, que ayudan a preservar los purgadores del barro, humedad y otros residuos, ya que son uno de los componentes del sistema del freno más delicados.

Queremos ofrecerte el mejor precio posible en nuestros protectores de rosca, por ello al comprar 10 unidades de la misma referencia accederás a un precio especial (añade una X al final de cada referencia, por ejemplo: RP4604X).



Imagen	Cota	Tipo	Ø	Ref.
		Presión	7,00	RP4604
		Presión	9,00	RP4605
		Presión	11,00	RP4606
		Presión	12,70	RP4607
		Roscado	10x100	RP4054
		Roscado	12x100	RP4107
		Roscado	12x150	RP4056
		Sangrador	5,00	RP5795

RP RACOR PROTECTOR

Ref.	Ø	Tipo	Cota	Imagen
RP5841	5,40	Sangrador		
RP5392	5,40	Sangrador		

TIPS

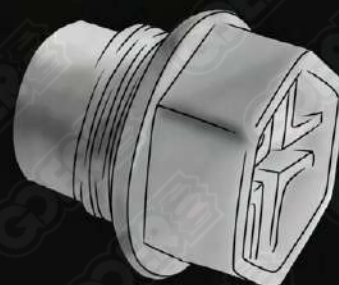
Recientemente hemos incorporado a nuestro catálogo un nuevo protector para los sangradores de freno: nuestra referencia RP5392.

A diferencia de los tradicionalmente utilizados, este guardapolvos protege el 100% del sangrador impidiendo que el óxido penetre, no sólo en la entrada de líquido, sino también en los hilos de la rosca.

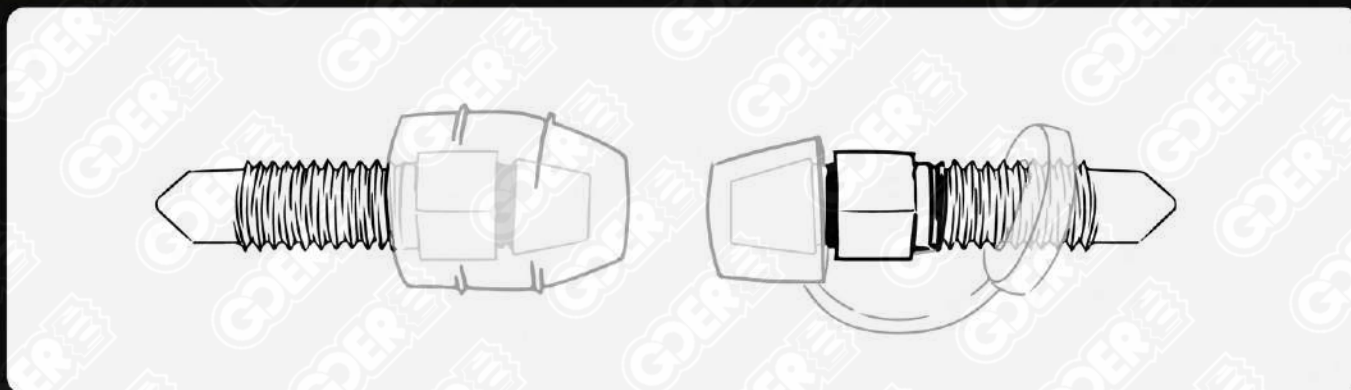

RA RACOR ANULADOR



Aquí tienes un conjunto de racores ciegos o tapones, tanto machos como hembras. Es importante recordar que habitualmente el freno hace cierre a través del asiento y si el anulador es plano deberá de ir combinado con una arandela.

Queremos ofrecerte el mejor precio posible en nuestros tapones ciegos, por ello al comprar 5 unidades de la misma referencia accederás a un precio especial (añade una V al final de cada referencia, por ejemplo: RA9700V).



Imagen	Cota	Ref.	Rosca
		RA9700	9x1.25
		RA9020	3/8x24
		RA7160	3/8x24
		RA0500	10x100
		RA9800	10x100
		RA8002	10x100
		RA7164	10x100
		RA9860	10x100

9x1.25

3/8x24

10x100

RA RACOR ANULADOR

Rosca Ref. Cota Imagen

10x100

RA5029

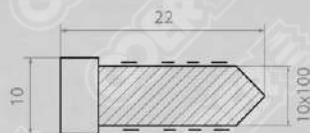

RA9810

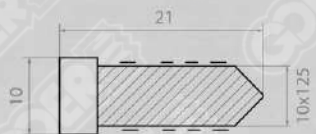

10x125

RA8003

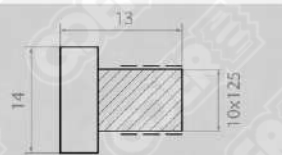

RA7165

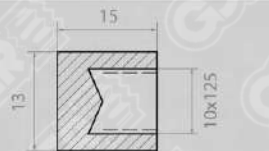

7/16x20

RA9010

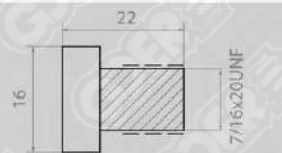

RA7162

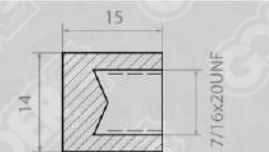

7/16x24

RA7161

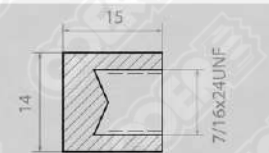

12x100

RA9901

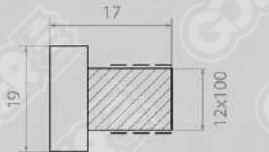

RA7166

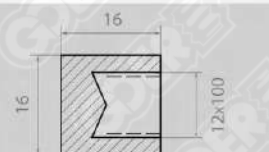

12x150

RA8001



Imagen	Cota	Ref.	Rosca
		RA7167	12x150
		RA7163	1/2x20
		RA9340	1/2x20
		RA9620	14x100

TIPS

Siempre que el asiento de la rosca lo permita resulta más eficiente colocar un sangrador en lugar de un tapón, no sólo por economía, ya que el precio del sangrador suele ser bastante inferior al tapón, sino que además disponemos de un punto de purgado extra en el circuito que nos puede ser de más ayuda de la que pensamos.

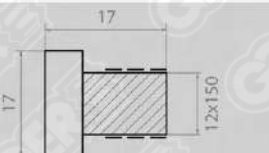
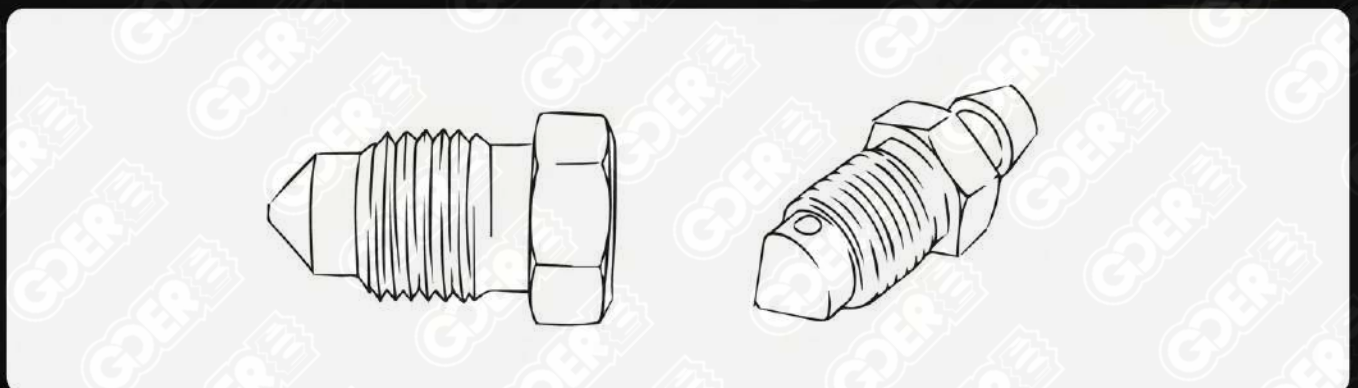

RB RACOR BANJO



Existen muchas denominaciones para estos tornillos, los cuales son utilizados para conectar una línea de freno con un accesorio banjo a la rueda. Un tornillo banjo permite una conexión más flexible y de perfil bajo para ayudar a que las ruedas giren.

Queremos ofrecerte el mejor precio posible en nuestros tornillos banjos, por ello al comprar 5 unidades de la misma referencia accederás a un precio especial (añade una V al final de cada referencia, por ejemplo: RB9370V).



Imagen	Cota	Ref.	Rosca
		RB9370	3/8x24
		RB4251	10x100
		RB4254	10x100
		RB4256	10x100
		RB4258	10x100
		RB4259	10x100
		RB8078	10x100
		RB8079	10x125

3/8x24

10x100

10x125

Rosca Ref. Cota Imagen

10x150

RB4252

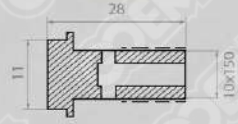

RB4257

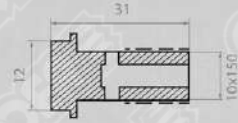

7/16x20

RB8011

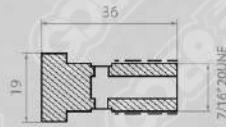

RB4250

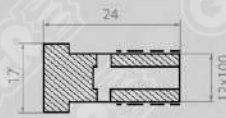

12x100

RB4253

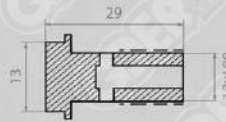

RB4255

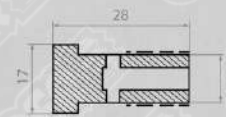

RB9160

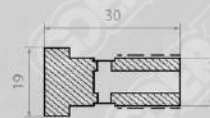

12x125

RB8081

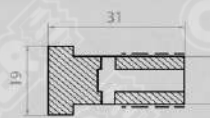

12x150

RB8080

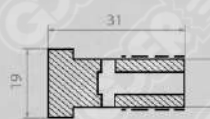

1/2x20

RB8010



Imagen	Cota	Ref.	Rosca
		RB9730	14X150

TIPS

Es muy importante que los tornillos banjos sean compatibles con los ojalos. Cuando utilices un ojal y éste tenga un canal en su interior por donde circule el líquido no hay problema. Tampoco si el tornillo banjo tiene una ranura.

Por el contrario, el flujo del líquido se puede reducir si se utilizan un tornillo y un banjo incompatibles, careciendo ambos de canal.

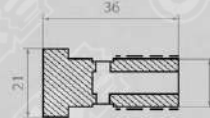

BIEN
La cabeza del banjo crea un canal alrededor del racor banjo.



BIEN
El racor banjo tiene una ranura en el puerto de entrada.



MAL
No hay sitio para que el fluido alcance el puerto de entrada.

RJ RACOR OJAL



Estos adaptadores de banjo te permiten conectar el extremo de la manguera o tubería de una forma más cómoda ya que se puede colocar perpendicularmente. Te presentamos una excelente manera de realizar una conexión fluida en un lugar estrecho donde una conexión tradicional no funcionaría.

Queremos ofrecerte el mejor precio posible en nuestros ojales, por ello al comprar 5 unidades de la misma referencia accederás a un precio especial (añade una V al final de cada referencia, por ejemplo: RJ7060V).



Imagen	Cota	Ø	Ref.	Rosca
		10	RJ7151	
		10	RJ7152	
		10	RJ7150	
		10	RJ9360	
		10,2	RJ7060	
		12,2	RJ9650	
		10	RJ5359	
		10,2	RJ7061	

3/8x24

10x100

Rosca Ref. Ø Cota Imagen

10x100

RJ8076

12

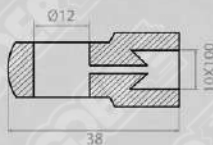

RJ9111

14

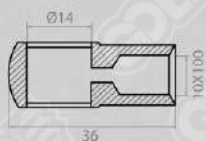

RJ8070

12

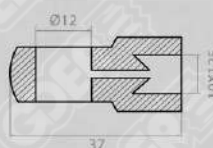

10x125

RJ8071

14

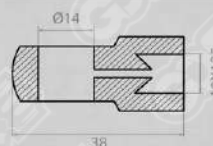

RJ9180

14

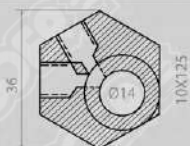

7/16x20

RJ7155

10

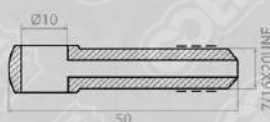

7/16x24

RJ8001

13,6

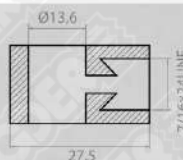

RJ7062

11,2

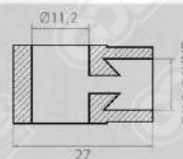

12x100

RJ8074

14

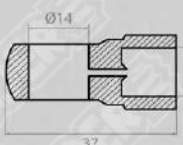

12x125

RJ8075

14



Imagen	Cota	Ø	Ref.	Rosca
		12,9	RJ7063	1/2x20
		14	RJ7271	

1/2x20

Hemos seleccionado una serie de racores de freno de máxima rotación de las familias más interesantes de nuestro catálogo. Al vender un conjunto completo podemos ofrecerte un precio más competitivo. De esta manera, con una pequeña inversión inicial vas a poder tener una cobertura de 95% de tus futuras necesidades y luego ir reponiendo cada referencia a medida que tenga consumo.

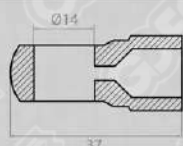

Kit para comprobar ABS

RK0010A

Pieza	Ref.	Unidades
Racor Tee 10x100 T	RT0127	2
Racor Reductor H12x100 - M10x100	RR0132	6
Lenteja de Freno Ovalillo Inversor 8Ø	LF5430	6

La composición de este maletín está diseñada para que puedas descartar que el fallo hidráulico que detectas, provenga del módulo de ABS. Con estos componentes podrás puentear entradas y salidas, emulando la función del componente hidráulico.

Kit para comprobar Bombas de Freno y Embrague

RK0010B

Racor Sangrador 7/16x20	RS9200	2
Racor Sangrador 10x100	RS0039	4
Racor Sangrador 12x100	RS0040	4
Racor Sangrador 3/8x24	RS0132	4
Racor Reductor H10x100 - M10x100	RR0230	2
Racor Reductor H10x100 - M3/8x24	RR0231	2
Racor Reductor H10x100 - M12x100	RR0129	2
Lenteja de Freno Ovalillo Inversor 8Ø	LF5430	4

La composición de este maletín ha sido seleccionada para que puedas comprobar si un cilindro maestro de freno o embrague guarda la estanqueidad al ejercer presión en el vástago o empujador.

Kit para comprobar Reguladores de Frenada en coches clásicos

RK0010C

Racor Tee 12x100 T	RT0128	1
Racor Reductor H10x125 - M12x100	RR0139	3
Racor Tee 3/8x24 T	RT0140	1
Lenteja de Freno Ovalillo Inversor 8Ø	LF5430	6
Racor Sangrador 12x100	RS0040	1

La composición de este maletín ha sido elegida para que puedas descartar, en tu vehículo clásico, que tu regulador de frenada sea el causante de la falta de presión en el circuito. Combinando los racores conseguirás puentear entradas y salidas.

Kit para comprobar Reguladores de Frenada

RK0010R

Racor Tee 3/8x24 T	RT0140	1
Racor Reductor H10x100 - M3/8x24	RR0231	3
Lenteja de Freno Ovalillo Inversor 8Ø	LF5430	3
Racor Sangrador 10x100	RS0039	2

La composición de este maletín, ha sido seleccionada para que puedas descartar que tu regulador de frenada este causando la falta de presión en el circuito. Combinando los diferentes racores y puentear las entradas y salidas veras si el pedal recupera la presión.

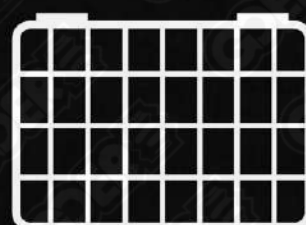

Kit Racores Machos y Hembras

32 refs. / 260 racores

RK0260M

Pieza	Ref.	Unidades
Racor Macho 8x125 3,70Ø	RM0120	5
Racor Macho 9x125 4,70Ø	RM0160	5
Racor Macho 3/8x24 5Ø	RM0109	30
Racor Macho 3/8x24 5Ø	RM0115	5
Racor Macho 3/8x24 5Ø	RM0117	5
Racor Macho 10x100 5Ø	RM0105	30
Racor Macho 10x100 5Ø	RM0116	5
Racor Macho 10x100 5Ø	RM0505	5
Racor Macho 10x125 5Ø	RM0112	10
Racor Macho 7/16x20 5Ø	RM0114	10
Racor Macho 7/16x20 6,50Ø	RM0170	10
Racor Macho 7/16x24 5,20Ø	RM0414	10
Racor Macho 7/16x24 6,5Ø	RM0172	10
Racor Macho 12x100 5Ø	RM0104	30
Racor Macho 12x100 5Ø	RM0118	5
Racor Macho 12x100 6,50Ø	RM0103	5
Racor Macho 12x125 6,50Ø	RM0161	5
Racor Macho 14x100 6,50Ø	RM0162	5
Racor Macho 14x125 6,50Ø	RM0163	5
Racor Macho 14x150 8,30Ø	RM0164	5
Racor Hembra 3/8x24 5Ø	RH0111	5
Racor Hembra 3/8x24 5Ø	RH0110	5
Racor Hembra 10x100 5Ø	RH0106	5
Racor Hembra 10x100 5Ø	RH0108	5
Racor Hembra 10x100 5Ø	RH0408	5
Racor Hembra 10x100 5Ø	RH0210	5
Racor Hembra 7/16x20 6,70Ø	RH0175	5
Racor Hembra 12x100 5Ø	RH0107	5
Racor Hembra 12x100 6,20Ø	RH0207	5
Racor Hembra 14x150 8,20Ø	RH0165	5
Racor Macho 3/8x24 4,95Ø	RM0167	5
Racor Macho 10x125 5Ø	RM0113	5

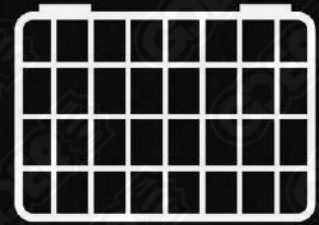

Kit Racor Sangrador

32 refs. / 160 racores

RK0160S

Pieza	Ref.	Unidades
Racor Sangrador 1/4x28	RS0120	5
Racor Sangrador 1/4x28	RS0220	5
Racor Sangrador 1/4x28	RS0105	5
Racor Sangrador 10x100	RS0018	5
Racor Sangrador 10x100	RS0019	5
Racor Sangrador 10x100	RS0039	5
Racor Sangrador 10x100	RS0131	5
Racor Sangrador 10x125	RS0101	5
Racor Sangrador 10x125	RS0103	5
Racor Sangrador 12x100	RS0040	5
Racor Sangrador 3/8x24	RS0049	5
Racor Sangrador 3/8x24	RS0107	5
Racor Sangrador 3/8x24	RS0108	5
Racor Sangrador 3/8x24	RS0132	5
Racor Sangrador 6x100	RS0013	5
Racor Sangrador 6x100	RS0033	5
Racor Sangrador 7x100	RS0053	5
Racor Sangrador 7x100	RS0253	5
Racor Sangrador 7x100	RS0069	5
Racor Sangrador 7x100	RS0086	5
Racor Sangrador 7x100	RS0087	5
Racor Sangrador 7x100	RS0088	5
Racor Sangrador 7x100	RS0094	5
Racor Sangrador 8x100	RS0089	5
Racor Sangrador 8x100	RS0090	5
Racor Sangrador 8x100	RS0091	5
Racor Sangrador 8x125	RS0085	5
Racor Sangrador 8x125	RS0010	5
Racor Sangrador 8x125	RS0011	5
Racor Sangrador 8x125	RS0100	5
Racor Sangrador 8x100	RS5808	5
Racor Sangrador 10x100	RS5006	5



Kit Conectores y Reductores

32 refs. / 64 racores

RK0064R

Pieza	Ref.	Unidades
Racor Reductor H8x100 - M10x100	RR0235	2
Racor Reductor H10x100 - M12x100	RR0129	2
Racor Reductor H10x100 - M10x100	RR0135	2
Racor Reductor H10x100 - M10x125	RR0136	2
Racor Reductor H10x100 - M12x100	RR0229	2
Racor Reductor H10x100 - M10x100	RR0230	2
Racor Reductor H10x100 - M3/8x24	RR0231	2
Racor Reductor H10x100 - M10x100	RR0232	2
Racor Reductor H10x100 - M12x125	RR0234	2
Racor Reductor H10x125 - M10x100	RR0137	2
Racor Reductor H10x125 - M10x125	RR0138	2
Racor Reductor H10x125 - M12x100	RR0139	2
Racor Reductor H10x125 - M12x125	RR0144	2
Racor Reductor H12x100 - M10x100	RR0132	2
Racor Reductor H12x100 - M10x125	RR0146	2
Racor Reductor H12x100 - M12x100	RR0147	2
Racor Reductor H10x100 - M12x100	RR0335	2
Racor Conector M 3/8x24 3/8x24	RC0134	2
Racor Conector H 3/8x24 3/8x24	RC0142	2
Racor Conector H 3/8x24 3/8x24	RC0143	2
Racor Conector H 10x100 10x100	RC0121	2
Racor Conector H 10x100 10x100	RC0124	2
Racor Conector M 10x100 10x100	RC0133	2
Racor Conector H 10x100 3/8x24	RC0301	2
Racor Conector H 10x100 10x100	RC0302	2
Racor Conector H 10x125 10x125	RC0122	2
Racor Conector H 10x125 10x100	RC0123	2
Racor Conector M 10x125 10x125	RC0149	2
Racor Conector H 12x100 12x100	RC0130	2
Racor Conector H 12x100 10x100	RC0131	2
Racor Conector H 12x100 12x125	RC0145	2
Racor Conector H 12x100 12x100	RC0148	2

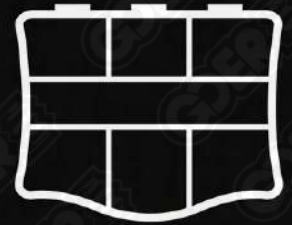

Kit Racores de Empalme

7 refs. / 35 racores

RK0035E

Pieza	Ref.	Unidades
Racor Empalme 3,56Ø	RE0151	5
Racor Empalme 4,55Ø	RE0152	5
Racor Empalme 4,80Ø	RE0150	5
Racor Empalme 5,20Ø	RE0156	5
Racor Empalme 6,05Ø	RE0153	5
Racor Empalme 6,40Ø	RE0154	5
Racor Empalme 8,05Ø	RE0155	5

Kit Racores Tee

7 refs. / 35 racores

RK0040T

Racor Tee 3/8x24 T	RT0140	5
Racor Tee 3/8x24 T	RT0141	5
Racor Tee 10x100 T	RT0126	5
Racor Tee 10x100 T	RT0127	5
Racor Tee 10x125 T	RT0125	5
Racor Tee 12x100 T	RT0128	5
Lenteja de Freno Inversora	LF5430	8

Kit Grapas de Freno

7 refs. / 70 grapas

RK0070G

Grapa de freno 1 Vía 4,80/6,00Ø	GF0158	10
Grapa de freno 1 Vía 4,80/6,00Ø	GF0159	10
Grapa de freno 2 Vías 4,80Ø	GF0260	10
Grapa de freno 2 Vías 4,80/8,00Ø	GF0261	10
Grapa de freno 3 Vías 4,80/8,00Ø	GF0362	10
Grapa de freno 3 Vías 4,80Ø	GF0363	10
Grapa de freno 1 Vía 6,00Ø	GF6380	10

Kit Arandelas de Freno

7 refs. / 70 arandelas

RK0070A



Pieza	Ref.	Unidades
Arandela de Freno Cobre 8x13x1,5	AF6061	10
Arandela de Freno Cobre 10x16x1,5	AF6065	10
Arandela de Freno Aluminio 10x16x1,5	AF6015	10
Arandela de Freno Cobre 11x16x1,5	AF6066	10
Arandela de Freno Aluminio 11x16x1,5	AF6016	10
Arandela de Freno Cobre 12x16x1,5	AF6067	10
Arandela de Freno Aluminio 12x16x1,5	AF6017	10

HF HIDROSTOP FRENO



El interruptor de luz de freno es un pequeño dispositivo conectado indirectamente al pedal de freno, que acciona la conexión eléctrica al detectar la presión del líquido de frenos. Te ofrecemos nuestros hidrostop con dos variantes: de conexión directa o a través de tornillo banjo.

Queremos ofrecerte el mejor precio posible en nuestros sensores de freno, por ello al comprar 5 unidades de la misma referencia accederás a un precio especial (añade una V al final de cada referencia, por ejemplo: HF8001V).



Imagen	Cota	Ø	Ref.	Rosca
		Roscado	HF8001	10x100
		Roscado	HF8002	10x125
		Banjo	HF8005	10x125
		Banjo	HF8004	12x125
		Banjo	HF8003	12x150

VF VÁLVULAS DE FRENO







El líquido de frenos tiene características que en ocasiones complican una reparación que en un principio parecía sencilla. Para solventar estas situaciones te ofrecemos válvulas de presión residual o limitadoras de presión.

Queremos ofrecerte el mejor precio posible en nuestras válvulas, por ello al comprar 5 unidades de la misma referencia accederás a un precio especial (añade una V al final de cada referencia, por ejemplo: VF9210V).

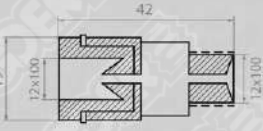

Imagen	Cota	R.Hembra	R.Macho	Ref.
		3/8x24	3/8x24	VF9210
		10x100	10x100	VF9190
		10x100	10x100	VF9310
		10x100	10x100	VF5273
		10x100	12x100	VF9240
		10x125	10x125	VF9130
		10x125	10x125	VF9170
		7/16x20	7/16x20	VF9220

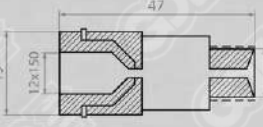
VF VÁLVULAS DE FRENO

Ref.	R.Hembra	R.Macho	Cota	Imagen
VF9250	12x100	12x100		
VF9230	12x150	12x150		

SF SERVO FRENO



Elementos neumáticos necesarios para el correcto funcionamiento del sistema de vacío. Al ser componentes de plástico y estar sometidos a cambios de temperaturas, en algunas ocasiones se deben sustituir debido a roturas o simplemente porque las válvulas anti retorno del interior dejaron de funcionar.

Queremos ofrecerte el mejor precio posible en nuestras componentes de servofreno, por ello al comprar 5 unidades de la misma referencia accederás a un precio especial (añade una V al final de cada referencia, por ejemplo: SF4067V).



Imagen	Cota	Tipo	Ø	Ref.
		Pipa servo	10	SF4067
		Pipa servo	13	SF4066
		Válvula servo	10	SF5024
		Válvula servo	13	SF5033

LF LENTEJA DE FRENO



Te ofrecemos una pequeña gama de ovalillos o lentejas de freno, útiles tanto para invertir o reparar el asiento posterior a la rosca (ya sea cóncavo o convexo), como para poder hacer cierre con tuerca de las tuberías de freno.



Queremos ofrecerte el mejor precio posible en nuestros ovalillos, por ello al comprar 10 unidades de la misma referencia accederás a un precio especial (añade una X al final de cada referencia, por ejemplo: LF8006X).



Imagen	Cota	Tipo	Ø	Ref.
		Ovalillo asiento	8	LF7244
		Ovalillo inversor	8	LF5430
		Ovalillo inversor	8	LF8006
		Ovalillo inversor	10	LF8008
		Ovalillo insertor	8	LF8007
		Ovalillo para tubo	5	LF6205
		Ovalillo para tubo	6	LF6206
		Ovalillo para tubo	8	LF6208

LF

LENTEJA DE FRENO

Ref.	Ø	Tipo	Cota	Imagen
LF6210	10	Ovalillo para tubo		

GF GRAPAS DE FRENO



Muchas veces se presentan dificultades para sujetar o amarrar al chasis tuberías y latiguillos. Como consecuencia, en ocasiones, lo hacemos de maneras inadecuadas por falta de recursos. Te presentamos algunos soportes que estamos seguros que te encajarán en cualquier circunstancia.

Queremos ofrecerte el mejor precio posible en nuestros accesorios del freno, por ello al comprar 10 unidades de la misma referencia accederás a un precio especial (añade una X al final de cada referencia, por ejemplo: GF0158X).



Imagen	Cota	Tipo	Ref.
		1 Vía	GF7249
		1 Vía	GF7250
		1 Vía	GF7035
		1 Vía	GF7034
		1 Vía	GF6380
		1 Vía	GF6381
		1 Vía	GF6382
		1 Vía	GF4250

GF GRAPAS DE FRENO

Ref.	Tipo	Cota	Imagen
GF4240	2 Vías		
GF4242	3 Vías		
GF0158	1 Vía		
GF0159	1 Vía		
GF0260	2 Vías		
GF0261	2 Vías		
GF0363	3 Vías		
GF0362	3 Vías		
GF4251	1 Vía		
GF4252	1 Vía		

Imagen	Cota	Tipo	Ref.
		1 Vía	GF4253
		2 Vías	GF4241
		4 Vías	GF4243

CF CIRCLIP FRENO



Ponemos a tu disposición un amplio listado de referencias de circlip o anillo de seguridad. Se trata de accesorios acerados y latonados, usados para la sujeción de latiguillos y tuberías de freno donde éste presente un rebaje.







Queremos ofrecerte el mejor precio posible en nuestros accesorios, por ello al comprar 10 unidades de la misma referencia accederás a un precio especial (añade una X al final de cada referencia, por ejemplo: CF5106X).

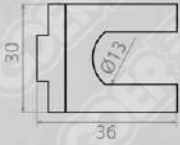

Imagen	Cota	Ø	Ref.
		10	CF4202
		10	CF4203
		10	CF4210
		10	CF4212
		10	CF4220
		10	CF4223
		12	CF5169
		12	CF4200

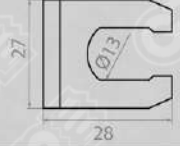
CF CIRCLIP FRENO

Ref.	Ø	Cota	Imagen
CF4206	12		
CF4213	12		
CF4216	12		
CF4222	12		
CF5106	13		
CF5107	13		
CF4201	13		
CF4205	13		
CF4207	13		
CF4208	13		

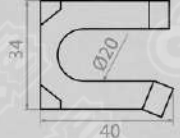
Imagen	Cota	Ø	Ref.
		13	CF4209
		13	CF4217
		13	CF4219
		13	CF4224
		15	CF4214
		20	CF4221

PF PIPA DE FRENO



Un surtido de las referencias más recurrentes de pipas de freno de tres variedades: roscadas, de presión o de cierre por grupilla. En muchas ocasiones estos elementos se dañan o deforman por golpes y altas temperaturas. Esto puede ocasionar obstrucciones que obligan a sustituirlos.

Queremos ofrecerte el mejor precio posible en nuestras pipas, por ello al comprar 5 unidades de la misma referencia accederás a un precio especial (añade una V al final de cada referencia, por ejemplo: PF8007V).



Imagen	Cota	Tipo	Ref.	Rosca/Ø
		Presión interior	PF9530	8
		Presión interior	PF9540	
		Presión interior	PF9310	13
		Presión interior	PF9300	
		Presión interior	PF9320	
		Presión interior	PF8008	20,5
		Grupilla	PF9030	13
		Grupilla	PF9020	13,5

PF PIPA DE FRENO

Rosca/Ø Ref. Tipo Cota Imagen

34

PF8007

Presión exterior

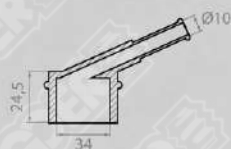

12x100

PF9940

Roscada



14x150

PF9370

Roscada

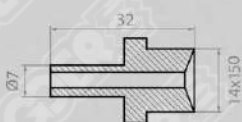

18x150

PF9211

Roscada

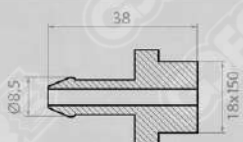

22x150

PF8001

Roscada

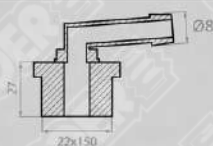

DF DEPÓSITOS DE FRENO



Los depósitos de expansión son un producto que suele mantenerse en perfecto estado durante toda la vida útil del vehículo, pero en ocasiones esto no es así, ya sea porque se ha usado un líquido inadecuado, porque se ha perdido el tapón o bien porque se está montando un nuevo circuito.



PIPA



Ref.	Tipo	Líquido
DF9040	Simple	DOT4
DF9041	Simple	LHM

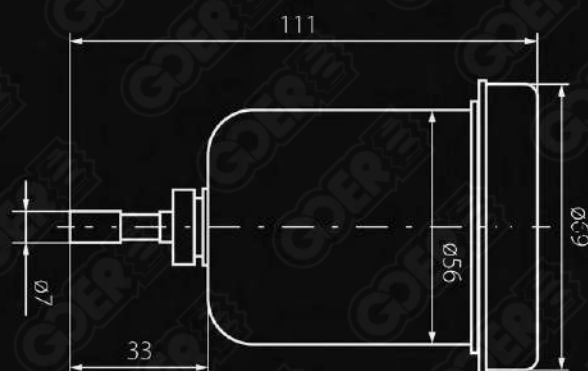

Ref.	Tipo	Líquido
DF9060	Doble	DOT4
DF9061	Doble	LHM

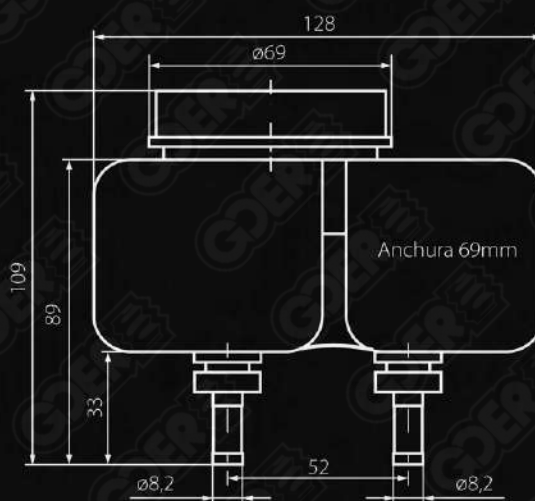

DF DEPÓSITOS DE FRENO

ROSCADO

Ref.	Tipo	Líquido
DF9320	16x150	DOT4
DF9321	16x150	LHM
DF9080	18x150	DOT4
DF9081	18x150	LHM
DF9050	22x150	DOT4
DF9051	22x150	LHM

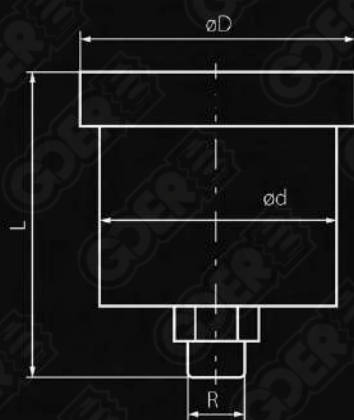

AF ARANDELAS DE FRENO



Los sistema hidráulicos de freno hacen cierre habitualmente a través del asiento, pero en ciertas ocasiones el cierre es gracias a una arandela de freno. Es importante disponer de las medidas de arandela de los diámetros más comunes, nosotros te ofrecemos todas ellas, tanto en cobre como en acero.

Queremos ofrecerte el mejor precio posible en nuestros accesorios del freno, por ello al comprar 10 unidades de la misma referencia accederás a un precio especial (añade una X al final de cada referencia, por ejemplo: AF6015X).



Ref.	Medidas	Material
AF6061	8x13x1,5	Cobre
AF6009	8x13x1,5	Aluminio
AF6064	10x14x1,5	Cobre
AF6014	10x14x1,5	Aluminio
AF6065	10x16x1,5	Cobre
AF6015	10x16x1,5	Aluminio
AF6066	11x16x1,5	Cobre
AF6016	11x16x1,5	Aluminio
AF6067	12x16x1,5	Cobre
AF6017	12x16x1,5	Aluminio
AF6071	14x18x1,5	Cobre
AF6021	14x18x1,5	Aluminio
AF6074	16x22x1,5	Cobre
AF6024	16x22x1,5	Aluminio
AF6077	18x24x1,5	Cobre
AF6027	18x24x1,5	Aluminio
AF6081	22x28x1,5	Cobre
AF6031	22x28x1,5	Aluminio

MF MUELLES DE FRENO



Esta ha sido la última adhesión a nuestro catálogo: muelles para pinzas con freno de mano. Son un producto muy difícil de localizar individualmente, por lo que hemos querido darle solución ofreciendo las referencias de máxima rotación.

Queremos ofrecerte el mejor precio posible en nuestros muelles, por ello al comprar 5 unidades de la misma referencia accederás a un precio especial (añade una V al final de cada referencia, por ejemplo: MF4500V).



MF4500

Modelo	Desde	Hasta
NISSAN Interstar	04.02	
OPEL Movano A	07.98	
RENAULT Master II	07.98	
VAUXHALL Movano I	10.98	- 12.10



MF4501

Modelo	Desde	Hasta
AUDI		
A1 Hatchback (8X1#)	05.10	- 10.18
A1 Sportback (8XA#)	09.11	- 10.18
A2 (8Z0)	02.00	- 08.05
A3 Hatchback (8L1)	09.96	- 05.03
A3 Hatchback Quattro (8L1)	03.99	- 05.03
A3 Hatchback Quattro (8L1)	12.96	- 08.00
TT Coupe (8N3)	10.98	- 06.06
TT Roadster (8N9)	10.99	- 06.06
CITROËN		
C2 (JM#)	07.03	- 10.10
C2 Enterprise	11.03	- 12.09
C3 I (FC_/FN_)	02.02	
C3 II (SC_)	11.09	
C3 Picasso	02.09	
C3 Pluriel (HB#)	05.03	
C4 Cactus	09.14	
C4 I Coupe (LA#)	11.04	- 07.11
C4 I Hatchback (LC#)	11.04	- 07.11
C4 II Hatchback (B7)	11.09	
C5 III	02.08	
C6 (TD#)	09.05	- 12.12
C8 (EA#/EB#)	07.02	
DS3	11.09	
DS4	04.11	- 07.15
Jumpy II Box	01.07	
Jumpy II MPV	01.07	
DS		
DS 3	04.15	- 07.19
DS 3	07.15	- 07.19
DS 3	09.15	- 07.19
FIAT		
Bravo II	11.06	
Scudo II (270#/272#)	01.07	
Talento (296#)	06.16	
Ulysse (179#)	08.02	- 06.11



MF MUELLES DE FRENO

MF4501

Continuación

Modelo	Desde	Hasta
FORD		
Galaxy I (WGR)	03.95	- 05.06
Transit Tourneo	07.06	- 08.14
LANCIA		
Delta III	09.08	- 08.14
Phedra	09.02	- 11.10
NISSAN		
Primastar	03.01	
OPEL		
Astra G Box	01.99	- 04.05
Astra G Caravan	02.98	- 12.09
Astra G Convertible	03.01	- 10.05
Astra G Coupe	03.00	- 05.05
Astra G Hatchback	02.98	- 12.09
Astra G Saloon	09.98	- 12.09
Astra H	01.04	
Combo C	10.01	- 01.12
Corsa C	06.03	- 12.09
Corsa D	08.06	- 08.14
Kadett E Saloon	09.84	- 05.92
Meriva A	05.03	- 05.10
Vivaro A (X83)	08.01	
Vivaro B (X82)	06.14	
Zafira A	04.99	- 06.05
Zafira B	07.05	- 04.15
PEUGEOT		
1007	04.05	
2008 I	03.13	
207 CC	02.07	- 01.15
207 Hatchback	02.06	- 12.13
207 SW	02.07	- 12.13
207 Van	04.06	
208 I	03.12	
307	08.00	
308 I CC	04.09	
308 I Hatchback	09.07	
308 I SW	09.07	
607	02.00	
Expert II Box (V#)	01.07	
Expert II Flatbed	01.07	
Expert II Tepee	01.07	
RENAULT		
Trafic II	03.01	
Trafic III (JG..)	05.14	
SEAT		
Alhambra (7V8/7V9)	04.96	- 03.10
Arosa	01.00	- 06.04
Cordoba (6K5) Vario	09.96	- 12.02
Cordoba (6L2) Saloon	09.02	- 11.09
Ibiza III	01.04	- 02.08
Ibiza III	02.02	- 11.09
Ibiza IV	03.08	- 06.17
Leon (1M1)	02.01	- 06.06
Leon (1M1)	11.99	- 06.06
Toledo II	10.98	- 05.06
Toledo IV	07.12	- 04.19
SKODA		
Fabia I Combi (6Y5)	04.00	- 12.07
Fabia I Hatchback (6Y2)	12.99	- 03.08
Fabia I Praktik (6Y5)	01.00	- 12.07
Fabia I Saloon (6Y3)	10.99	- 12.07
Fabia II Combi (5J/545)	10.07	- 12.14
Fabia II Hatchback (5J/542)	12.06	- 12.14
Fabia III Combi (NJ5)	10.14	
Fabia III Hatchback (NJ3)	08.14	
Octavia I Combi (1U5)	07.98	- 12.10
Octavia I Combi (1U5)	08.02	- 01.06
Octavia I Hatchback (1U2)	05.01	- 01.06
Octavia I Hatchback (1U2)	09.96	- 12.10

MF4501

Continuación

Modelo	Desde	Hasta
SKODA		
Rapid (NH#)	07.12	
Roomster (5J)	03.06	- 05.15
VAUXHALL		
Astravan IV	02.98	- 08.06
Combo II	09.01	- 02.12
Meriva I	01.03	- 06.10
Vivaro A (X83)	08.01	- 07.14
Vivaro B (X82)	05.14	
Zafira II	07.05	- 11.14
VW		
Bora Estate (1J6)	05.99	- 05.05
Bora Saloon (1J2)	10.98	- 05.05
Corrado	09.88	- 12.95
Golf III Convertible	07.93	- 05.98
Golf III Hatchback	08.91	- 07.98
Golf III Variant	07.93	- 04.99
Golf IV Hatchback	08.97	- 06.05
Golf IV Variant	10.97	- 06.06
Lupo	01.99	- 07.05
Multivan V	04.03	- 08.15
Multivan VI	04.15	
New Beetle	01.98	- 09.10
Passat Variant (3A5/351)	04.88	- 05.97
Polo (6N2)	10.99	- 09.01
Polo (6R#/6C#)	03.09	
Polo Classic (6KV2)	12.95	- 01.02
Polo Hatchback (9N#)	10.01	- 11.09
Polo Saloon (9A#/9N#)	09.02	
Polo Variant (6KV5)	05.97	- 09.01
Sharan (7M#)	09.95	- 03.10
Transporter IV Bus	09.90	- 06.03
Transporter IV Flatbed	07.90	- 04.03
Transporter V	04.03	- 08.15
Transporter VI	04.15	
Vento	11.91	- 09.98

MF4503

Modelo	Desde	Hasta
VW		
Jetta II	08.86	- 10.91
Passat Hatchback (32B)	01.81	- 07.83
Passat Variant (32B)	01.81	- 03.88

MF4504

Modelo	Desde	Hasta
AUDI		
A4 Avant (8D5/B5)	11.94	- 09.01
A4 Avant Quattro (8D5/B5)	01.96	- 09.01
A4 Avant Quattro (8K5/B8)	11.08	- 12.15
A4 Convertible (8H7/8HE)	03.04	- 03.09
A4 Saloon (8D2/B5)	11.94	- 11.00
A4 Saloon Quattro (8D2/B5)	01.95	- 09.01
A4 Saloon Quattro (8K2/B8)	11.08	- 12.15
A6 Avant (4B5/C5)	12.97	- 01.05
A6 Avant Quattro (4B5/C5)	12.97	- 01.05
A6 Saloon (4B2/C5)	01.97	- 01.05
A6 Saloon Quattro (4B2/C5)	02.97	- 01.05
A8 (4E#)	10.02	- 07.10



MF MUELLES DE FRENO

MF4504

Continuación

Modelo	Desde	Hasta
VW		
Golf Plus	12.04	- 12.13
Golf VI Variant	07.09	- 05.14
Phaeton	04.02	- 03.16
Touran (1T1/1T2)	02.03	- 05.10

MF4505

Modelo	Desde	Hasta
OPEL		
Astra G Box	01.99	- 04.05
Astra G Caravan	02.98	- 12.09
Astra G Convertible	03.01	- 10.05
Astra G Coupe	03.00	- 05.05
Astra G Hatchback	02.98	- 12.09
Astra G Saloon	09.98	- 12.09
VAUXHALL		
Astra IV Convertible	03.01	- 10.05
Astra IV Coupe	03.00	- 08.05
Astra IV Estate	02.98	- 05.05
Astra IV Hatchback	02.98	- 05.05
Astra IV Saloon	05.98	- 05.05
Astravan IV	02.98	- 08.06



MF4506

Modelo	Desde	Hasta
MAZDA		
626 III Coupe	06.87	- 05.92
626 III Estate	09.87	- 09.97
626 III Hatchback	06.87	- 05.92
626 III Saloon	07.87	- 05.92
929 III	06.87	- 06.91
MX-5 III	03.05	- 12.14



MF4507

Modelo	Desde	Hasta
FORD		
Mondeo III Hatchback	10.00	- 03.07
Mondeo III Saloon	10.00	- 03.07



MF4508

Modelo	Desde	Hasta
FORD		
Mondeo III Hatchback	10.00	- 03.07
Mondeo III Saloon	10.00	- 03.07
RENAULT		
Mégane I Grandtour	02.01	- 08.03



MF4509

Modelo	Desde	Hasta
SAAB		
900 I Convertible	11.86	- 06.94
900 I Hatchback	09.78	- 06.94
900 I Saloon	01.79	- 12.93
99 Hatchback	03.76	- 12.84
99 Saloon	09.74	- 12.84



MF4510

Modelo	Desde	Hasta
SAAB		
900 I Convertible	11.86	- 06.94
900 I Hatchback	09.79	- 06.94
900 I Saloon	11.80	- 12.93
99 Hatchback	09.84	- 12.98
99 Saloon	04.85	- 12.98



MF4511

Modelo	Desde	Hasta
FORD		
Scorpio I	04.85	- 12.94
Scorpio II	10.94	- 08.98
Sierra Estate (BNG)	01.87	- 02.93
Sierra Hatchback (GBC/GBG)	08.82	- 02.93
Sierra Saloon (GBC/GB4)	01.87	- 02.93



MF4512

Modelo	Desde	Hasta
ALFA ROMEO		
145	07.94	- 01.01
146	12.94	- 10.01
155	01.92	- 12.97
Spider (916#)	09.94	- 04.05
AUDI		
100 Avant Quattro (44/44Q/C3)	09.83	- 12.91
100 Avant Quattro (4A5/C4)	09.91	- 07.94
100 Saloon Quattro (4A2/C4)	08.91	- 07.94
200 Avant Quattro (44/44Q)	07.89	- 12.90
200 Saloon Quattro (44/44Q)	03.89	- 12.90
A6 Avant Quattro (4A5/C4)	06.94	- 12.97
A6 Saloon Quattro (4A2/C4)	06.94	- 10.97
Quattro (85)	07.80	- 07.91
FIAT		
Barchetta	04.95	- 05.05
Bravo I	10.95	- 10.01
Coupe	11.93	- 08.00
Punto Hatchback (176#)	10.93	- 07.99
Tempra Saloon	05.90	- 09.96
Tempra SW	03.90	- 08.96
Tipo (160#)	01.88	- 10.95
LANCIA		
Dedra	04.89	- 07.99
Delta II	06.93	- 09.99
PEUGEOT		
405 I Break	05.88	- 08.92
405 II Break	08.92	- 10.96
405 II Saloon	08.92	- 10.95



MF MUELLES DE FRENO

MF4513

Modelo	Desde	Hasta
HONDA		
Accord IV Saloon	01.90	- 03.93
Civic IV Hatchback	10.87	- 09.91
Civic V Saloon	10.91	- 11.95
Civic VI Aerodeck	04.98	- 02.01
Civic VI Fastback	09.94	- 02.01
Civic VI Hatchback	11.95	- 02.01
Civic VII	02.01	- 09.05
Concerto Hatchback	08.89	- 03.95
CRX II	10.87	- 02.92
CRX III	03.92	- 12.98
Prelude II	04.87	- 01.92
MG		
ZR	06.01	- 04.05
ROVER		
200 (RF)	11.95	- 03.00
200 (XW)	10.89	- 06.99
400 (RT)	03.95	- 03.00
400 (XW)	04.90	- 11.98
45 (RT)	02.00	- 05.05
Streetwise	08.03	- 05.05



MF4514

Modelo	Desde	Hasta
HONDA		
Accord III	11.85	- 12.89
Accord IV Coupe	01.92	- 09.93
Accord IV Estate	01.91	- 12.93
Accord IV Saloon	01.90	- 03.93
Accord V	03.93	- 02.98
Legend I	01.88	- 12.90



MF4515

Modelo	Desde	Hasta
NISSAN		
Almera II (N16)	01.00	- 11.06
Micra II (K11)	01.92	- 02.03
Primera (P11)	09.96	- 07.02
Primera (WP11)	06.96	- 12.01



MF4516

Modelo	Desde	Hasta
IVECO		
Daily III	05.99	- 07.07
Daily IV	05.06	- 03.12
Daily V	09.11	- 02.14
NISSAN		
Cabstar (F24#)	09.06	- 12.13



MF4517

Modelo	Desde	Hasta
MAZDA		
323 F VI	09.98	- 05.04
323 S VI	09.98	- 05.04
626 V	05.97	- 10.02
626 V Estate	02.98	- 10.02
Premacy	07.99	- 03.05



MF4518

Modelo	Desde	Hasta
OPEL		
Vectra C	04.02	- 01.09
SAAB		
9-3 (YS3F#/E50)	09.02	- 02.15
9-3X (YS3)	02.09	- 02.15
TOYOTA		
Yaris (#P13#)	12.10	
Yaris (#P9#)	08.05	- 12.12



MF4519

Modelo	Desde	Hasta
FORD		
Focus II Hatchback	10.05	- 09.12
Galaxy II (WA6)	05.06	- 06.15
Kuga I	02.08	- 11.12
Mondeo IV	03.07	- 01.15
S-Max I (WA6)	05.06	- 12.14



MF4520

Modelo	Desde	Hasta
MAZDA		
6 (GC/CY)	01.02	- 02.08
6 (GH)	08.07	- 07.13



MF4521

Modelo	Desde	Hasta
NISSAN		
NV400	11.11	
OPEL		
Movano B	05.10	
RENAULT		
Master III	02.10	



MF MUELLES DE FRENO

MF4522

Modelo	Desde	Hasta
CITROËN		
C4 Grand Picasso I (UA#)	10.06	- 12.13
C4 I Coupe (LA#)	11.04	- 07.11
C4 I Hatchback (LC#)	11.04	- 07.11
C4 Picasso I (UD#)	10.06	- 08.13
FIAT		
Grande Punto (199#)	10.05	
Punto (199#)	03.12	
Punto Evo (199#)	10.09	- 02.12
Stilo	10.01	- 08.08
FORD		
Transit IV Box (F#)	04.06	- 12.14
Transit IV Bus (F#)	04.06	- 12.14
Transit IV Flatbed (F#)	04.06	- 08.14
Transit V	08.13	
PEUGEOT		
307	08.00	



MF4523

Modelo	Desde	Hasta
JAGUAR		
S-Type (X200)	01.99	- 10.07
S-Type (X200)	04.02	- 10.07
XJ (X350/X358)	03.03	- 03.09
NISSAN		
Almera II (N16)	01.00	- 09.06
Almera II (N16)	03.00	- 11.06
Almera II (N16)	09.03	- 09.06



MF4524

Modelo	Desde	Hasta
TOYOTA		
Avenis (#T27#)	11.08	- 10.18



MF4525

Modelo	Desde	Hasta
ALFA ROMEO		
145	07.94	- 01.01
155	01.92	- 12.97
GTV (916#)	06.95	- 10.05
Spider (916#)	09.94	- 04.05
Spider (939#)	03.06	- 03.11
CITROËN		
Berlingo I	07.96	
Berlingo II	04.08	
DS5	11.11	- 07.15
Xsara Picasso (N68)	12.99	
FIAT		
Barchetta	04.95	- 05.05
Bravo I	10.95	- 10.01
Coupe	11.93	- 08.00
Marea Saloon	05.96	- 12.02
Marea Weekend	09.96	- 12.02



MF4525

Continuación

Modelo	Desde	Hasta
FORD		
Fiesta V Hatchback	03.05	- 06.08
Focus I	08.98	- 03.05
LANCIA		
Dedra	04.89	- 07.99
Delta II	06.93	- 09.99
OPEL		
Corsa C	09.00	- 12.09
Tigra TwinTop (X04)	06.04	- 12.10
PEUGEOT		
5008 I	06.09	- 03.17
508 I SW	11.10	
Partner I	06.96	- 12.15
Partner I Combispace	06.96	- 12.15
Partner II Tepee	04.08	
RENAULT		
Fluence	02.10	
Grand Scénic II	03.04	- 06.09
Mégane CC	06.10	
Mégane II Convertible	09.03	- 12.09
Mégane II Estate	08.03	- 08.09
Mégane II Hatchback	09.02	- 12.09
Mégane II Saloon	08.03	
Mégane III Coupe	11.08	
Mégane III Grandtour	11.08	
Mégane III Hatchback	11.08	
Scénic II	06.03	- 06.09
Wind	07.10	
TOYOTA		
Avensis (#T22#)	09.97	- 02.03

MF4526

Modelo	Desde	Hasta
CITROËN		
C4 Aircross	04.12	
MITSUBISHI		
ASX	02.10	
Outlander III	08.12	
PEUGEOT		
4008	05.12	

MF4527

Modelo	Desde	Hasta
AUDI		
A3 Convertible (8P7)	04.08	- 05.13
A3 Hatchback (8P1)	05.03	- 08.12
A3 Hatchback Quattro (8P1)	05.03	- 08.12
A3 Sportback (8PA)	09.04	- 03.13
A3 Sportback Quattro (8PA)	09.04	- 03.13
TT Coupe (8J3)	07.09	- 06.14
TT Roadster (8J9)	03.07	- 06.14
OPEL		
Insignia A	07.08	- 03.17
Insignia A	07.09	- 03.17
SEAT		
Altea	03.04	
Altea XL	10.06	
Leon (1P1)	05.05	- 08.13
Toledo III	04.04	- 05.09



MF MUELLES DE FRENO

MF4527

Continuación

Modelo	Desde	Hasta
SKODA		
Octavia II Combi (1Z5)	02.04	- 06.13
Octavia II Hatchback (1Z3)	02.04	- 06.13
Superb II Combi (3T5)	10.09	- 05.15
Superb II Hatchback (3T4)	03.08	- 05.15
Yeti (5L)	05.09	- 12.17
SAAB		
9-5 Saloon (YS3G)	05.10	- 01.12
VAUXHALL		
Insignia I	07.08	- 05.17
VW		
Beetle (5C#)	04.11	- 07.19
Eos	03.06	- 08.15
Golf Plus	12.04	- 12.13
Golf V Hatchback	10.03	- 02.09
Golf V Variant	06.07	- 07.09
Golf VI Convertible	03.11	-
Golf VI Hatchback	10.08	- 11.13
Jetta III	09.04	- 10.10
Jetta IV	04.10	-
Scirocco (137/138)	05.08	- 11.17

MF4528

Modelo	Desde	Hasta
FORD		
C-Max I	02.07	- 09.10
C-Max II	04.10	-
Focus C-Max (DM2)	10.03	- 03.07
Focus II Estate	07.04	- 09.12
Focus II Hatchback	07.04	- 09.12
Focus II Saloon	04.05	- 09.12
Focus III	07.10	-
Grand C-Max	12.10	-
Kuga II	03.13	-
Tourneo Connect II	09.13	-
Transit Connect	02.13	-
MAZDA		
3 (BK)	10.03	- 12.09
3 (BL)	12.08	- 09.14
3 (BM/BN)	07.13	-
5 (C#)	02.05	-
VOLVO		
C30	10.06	- 12.12
C70 II	03.06	- 06.13
S40 II	01.04	- 12.12
V40 II	03.12	-
V50	04.04	- 12.12



MF4529

Modelo	Desde	Hasta
HONDA		
Civic VIII (FN/FK)	09.05	-
Civic IX Hatchback	02.12	-
Civic IX Saloon	09.11	-



TF TUBERÍAS DE FRENO



Disponemos de uno de los catálogos más amplios de tubería rígida y manguera para freno que existen, donde encontrarás incluso diámetros difíciles de localizar (como 3.5 mm para los antiguos Citroën) o poco habituales, llegando hasta los 12 mm de diámetro. Te ofrecemos diversos formatos de bobina con diferentes composiciones: cobre con níquel, cobre puro o también de acero con tratamiento PVF (el material que monta el 90% de los vehículos del mercado en origen).



COBRE



Ref.	Ø	Formato
TF3505C	3,50	5
TF3510C	3,50	10
TF3525C	3,50	25
TF4510C	4,50	10
TF4705C	4,75	5
TF4710C	4,75	10
TF4725C	4,75	25
TF5005C	5,00	5
TF5010C	5,00	10
TF5025C	5,00	25
TF6005C	6,00	5
TF6010C	6,00	10
TF6025C	6,00	25
TF6305C	6,35	5
TF6310C	6,35	10
TF6325C	6,35	25
TF8010C	8,00	10
TF8025C	8,00	25
TF1010C	10,00	10
TF1210C	10,00	10



NIQUEL

TF3510N	3,50	10
TF4710N	4,75	10
TF6010N	6,00	10
TF6310N	6,35	10
TF8010N	8,00	10
TF1010N	10,00	10

TF TUBERÍAS DE FRENO FAMILIA

ACERO

Ref.	Ø	Formato
TF4710H	4,75	10
TF4725H	4,75	25
TF6010H	6,00	10
TF6025H	6,00	25
TF6310H	6,35	10
TF6325H	6,35	25
TF8010H	8,00	10



Muchas veces resulta difícil de localizar tubo de goma negra sin refuerzo, apta para el paso de líquido de frenos DOT3, DOT4 y DOT5.1. Te lo ofrecemos en formato de bobinas de 25 metros y con diferentes diámetros exteriores e interiores. Para el servofreno ofrecemos manguera de depresión en formatos de 10 metros y diferentes diámetros.

DOT4

TF0425D	4,75	25
TF0625D	6,00	25
TF0825D	8,00	25



SERVO

TF0610S	6,00	10
TF1010S	10,00	10



UF UTILLAJE DE FRENO



Ponemos a su disposición un catalogo de utillaje y herramientas específicas para todo aquello que engloba al sistema de freno, distribuimos diferentes marcas referentes del mercado en este tipo de productos, garantizando la máxima calidad al mejor precio.



Abocardador Simple Ref.: UF0250

Abocardador simple para tuberías de distintas medidas:
4,75 mm
6,35 mm
8 mm
9,52 mm

Abocardador Ligero Ref.: UF5918

Abocardador ligero para tuberías de 4,75 mm



Abocardador Ligero Ref.: UF0414

Abocardador ligero para tuberías de distintas medidas:
4,75 mm
6 mm
6,35 mm

Abocardador de giro Horizontal Ref.: UF0100

Abocardador con eje de giro horizontal para tuberías de distintas medidas:
4,75 mm
6,35 mm



UF UTILLAJE DE FRENO FAMILIA



Abocardador de giro Vertical
Ref.: UF0350

Abocardador con eje de giro vertical para tuberías de distintas medidas:
4,75 mm 8,00 mm
6,00 mm 9,52 mm
6,35 mm

Abocardador Clásico
Ref.: UF0003

Abocardador clásico para tuberías de distintas medidas:
3,50 mm
4,50 mm
6,35 mm



Cortador Mini
Ref.: UF0130

Cortador mini para tuberías 3-16 mm

Cortador para Tuberías
Ref.: UF0110

Cortador para tuberías 3-28 mm



Cortador para Tuberías de Carraca
Ref.: UF5339

Cortador para tuberías de carraca de 4,75 mm

Doblador de Tuberías 90°
Ref.: UF0346

Doblador de tuberías de 3-6 mm
Ángulo 0°-90°



Doblador de Tuberías 180°
Ref.: UF0312

Doblador de tuberías 6-10 mm
Ángulo 0°-180°

Doblador de Tuberías 90°
Ref.: UF0410

Doblador de tuberías 4,75-10 mm
Ángulo 0°-90°



Escariador
Ref.: UF0601

Escariador para tubería de freno

Juego de Llaves de Purgado
Ref.: UF5622

Maletín con juego de llaves de purgado
8 mm
10 mm
11 mm



UF UTILLAJE DE FRENO FAMILIA



Juego de Llaves de Purgado
Ref.: UF5516

Juego de llaves de purgado de diversos tamaños:
7 mm 10mm
8 mm 11 mm
9 mm 12 mm

Juego de Llaves de Purgado
Ref.: UF5633

Juego de llaves de purgado de 5 piezas
7 mm 10 mm
8 mm 11 mm
9 mm



Llave Especial para Tubo de Freno
Ref.: UF5760

Llave especial para tubo de freno de 10x11 mm

Útil para Muelle Tambor
Ref.: UF5135

Útil para muelle tambor



Útil para Montaje de Muelle
Ref.: UF5018

Útil para montaje de muelle

Alicate para Muelle
Ref.: UF5432

Alicate para muelle



Extracción de Muelle de Zapata
Ref.: UF5308

Extracción de muelle de zapata

Punzón para Pernos de Freno
Ref.: UF5001

Punzón para pernos de freno



Alicate para Muelle con Uña
Ref.: UF5817

Alicate para muelle con uña

Alicate para Muelle
Ref.: UF5642

Alicate para muelle



UF UTILLAJE DE FRENO FAMILIA



Alicata para Cable
Ref.: UF5831

Alicata para cable FM

Útil para Extraer Muelle de Freno
Ref.: UF5707

Útil para extraer el muelle de freno



Juego de Mantenimiento y Montaje
Ref.: UF5818

Juego de mantenimiento y montaje

Juego de Bloqueo de Manguera
Ref.: UF5719

Juego de bloqueo de manguera de 5 piezas



Juego de Reparación
Ref.: UF5833

Juego de reparación de 6 piezas

Estrangulador de Tubos de Freno
Ref.: UF5322

Estrangulador de tubos de freno y manguitos



Juego de Vasos para Pinzas
Ref.: UF5697

Juego de vasos para pinzas de 11 piezas

Surtido de Alicates de Circlip
Ref.: UF5426

Surtido de alicates de circlip de 4 piezas



Cepillo de Alambre de Acero
Ref.: UF5798

Cepillo de alambre de acero

Cepillo de Alambre de Latón
Ref.: UF5981

Cepillo de alambre de latón



UF UTILLAJE DE FRENO FAMILIA



Juego de Galgas
Ref.: UF5166

Juego de galgas para espesor de frenos

Calibre Espesor de Discos
Ref.: UF5689

Calibre para espesor de discos



Calibre Diámetro de Discos y Tambores
Ref.: UF5392

Calibre para diámetro de discos y tambores 200-400 mm



Medidor de Presión de Frenos
Ref.: UF5413

Medidor de presión de frenos



Medidor de Presión de ABS y Frenos
Ref.: UF5964

Medidor de presión de ABS y frenos



Micrómetro
Ref.: UF5154

Micrómetro con base magnética



Juego de Purgado Neumático
Ref.: UF5087

Juego de purgado neumático de 11 piezas

Bomba de Vacío y Purgado
Ref.: UF5999

Bomba de vacío y purgado
MAX 0,7 BAR



Adaptadores para Purgado Neumático
Ref.: UF5014

Adaptadores para purgado neumático

Purgador por Aire Comprimido
Ref.: UF5315

Purgador por aire comprimido



UF UTILLAJE DE FRENO FAMILIA



Purgador Eléctrico
Ref.: UF5012

Purgador eléctrico
12 V
0,2/0,35 BAR

Reposicionador de Pistones
Ref.: UF5124

Reposicionador de pistones por dado de 10 mm



Reposicionador Simple de Pistones
Ref.: UF5126

Reposicionador simple de pistones
0-66 mm BGS

Reposicionador Simple de Pistones
Ref.: UF5015

Reposicionador simple de pistones por carraca



Reposicionador de Pistones maletín
Ref.: UF5519

Reposicionador de pistones FM
Maletín de 24 piezas

Reposicionador Neumático de Pistones
Ref.: UF5172

Reposicionador neumático de pistones
Maletín de 16 piezas



Reposicionador de Pistones Ajustable
Ref.: UF5609

Reposicionador de pistones ajustable

Reposicionador Neumático de Pistones
Ref.: UF5320

Reposicionador neumático de pistones
Cuadrado 3/8"



Reparador de Roscas de Pinza
Ref.: UF5090

Reparador de roscas de pinza M9

Reposicionador de Pistones
Ref.: UF5115

Reposicionador de pistones FM
Maletín de 35 piezas



UF UTILLAJE DE FRENO FAMILIA



Reposicionador Neumático de Pistones
Ref.: UF5114

Reposicionador neumático de pistones
Maletín de 22 piezas

Reparación de Pasador de Guías
Ref.: UF5347

Reparación de pasador de guías



Reparador de Roscas de Pinza
Ref.: UF5184

Reparador de roscas de pinza M12

Reparación de Válvulas de Sangrado
Ref.: UF5738

Reparación universal valvulas de purga 1/4 y 1/8 NPT



Purgador de Aire
Ref.: UF5535

Purgador de aire mediante sistema neumático

Pinzas para Mangueras en Ángulo
Ref.: UF4123

Pinzas para mangueras en ángulo
7 Piezas
Bandeja carro 1/3

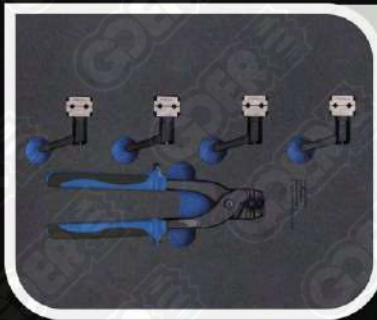

Doblador de Tubos y Juego de Abrazaderas
Ref.: UF5533

Doblador de tubos y juego de abrazaderas de tubo
4,75-6 mm \varnothing
Bandeja carro 1/3

Herramientas de Medición
Ref.: UF5031

Juego de herramientas de medición
Bandeja carro 1/3



Juego de Llaves de Purgado
Ref.: UF5513

Juego de Llaves de Purgado
Bandeja carro 1/6
8 mm
10 mm
11 mm

Llaves Estrella Abiertas y Especiales
Ref.: UF5048

Llaves estrella abiertas y especiales
13 Piezas
Bandeja carro 1/3

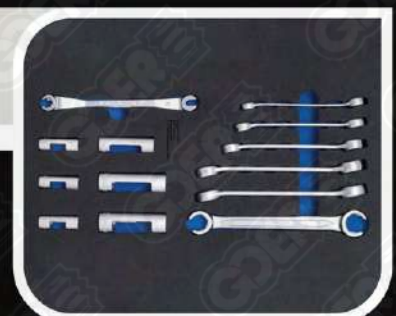

UF UTILLAJE DE FRENO FAMILIA



Reposicionador de Pistones
Ref.: UF5680

Reposicionador de pistones
Bandeja carro 1/3

Adaptadores Para Purgado Neumático
Ref.: UF5152

Juego de adaptadores para purgado neumático
Bandeja carro 1/3



Reposicionador de Pistones
Ref.: UF5102

Reposicionador de pistones FM
50 Piezas
Bandeja carro 2/3

Piezas Especiales para Freno
Ref.: UF5006

Piezas especiales para freno 2 FOAM
42 Piezas
Bandeja carro 3/3



ÍNDICE DE REFERENCIAS



RACOR MACHO

RM0102	Pag.	10
RM0103	Pag.	10
RM0104	Pag.	10
RM0105	Pag.	08
RM0109	Pag.	07
RM0112	Pag.	09
RM0113	Pag.	09
RM0114	Pag.	09
RM0115	Pag.	07
RM0116	Pag.	08
RM0117	Pag.	07
RM0118	Pag.	10
RM0119	Pag.	10
RM0120	Pag.	07
RM0131	Pag.	13
RM0160	Pag.	07
RM0161	Pag.	11
RM0162	Pag.	12
RM0163	Pag.	13
RM0164	Pag.	13
RM0166	Pag.	07
RM0167	Pag.	07
RM0168	Pag.	07
RM0169	Pag.	10
RM0170	Pag.	09
RM0171	Pag.	12
RM0172	Pag.	10
RM0173	Pag.	12
RM0174	Pag.	12
RM0202	Pag.	10
RM0203	Pag.	11
RM0204	Pag.	10
RM0205	Pag.	08
RM0214	Pag.	09
RM0216	Pag.	08
RM0270	Pag.	09
RM0271	Pag.	12
RM0303	Pag.	11
RM0405	Pag.	08
RM0414	Pag.	10
RM0505	Pag.	08
RM0605	Pag.	08
RM4130	Pag.	11
RM4145	Pag.	11
RM4174	Pag.	12
RM4175	Pag.	12
RM4176	Pag.	12
RM4262	Pag.	13
RM4264	Pag.	13
RM4265	Pag.	13
RM5006	Pag.	09
RM5007	Pag.	08

RM6157	Pag.	12
RM6408	Pag.	09
RM6410	Pag.	09
RM7188	Pag.	09
RM7193	Pag.	11
RM7198	Pag.	13
RM7199	Pag.	13
RM8005	Pag.	11
RM8009	Pag.	12
RM9040	Pag.	11
RM9150	Pag.	08
RM9282	Pag.	11
RM9550	Pag.	11
RM9620	Pag.	08

RACOR HEMBRA

RH0106	Pag.	15
RH0107	Pag.	16
RH0108	Pag.	15
RH0110	Pag.	15
RH0111	Pag.	15
RH0165	Pag.	16
RH0175	Pag.	16
RH0207	Pag.	16
RH0210	Pag.	15
RH0408	Pag.	15
RH4269	Pag.	17
RH5010	Pag.	15
RH5102	Pag.	15
RH5103	Pag.	16
RH6422	Pag.	16
RH6423	Pag.	16
RH6427	Pag.	16
RH7177	Pag.	16
RH7178	Pag.	16

RACOR SANGRADOR

RS0010	Pag.	20
RS0011	Pag.	21
RS0013	Pag.	19
RS0015	Pag.	21
RS0017	Pag.	21
RS0018	Pag.	21
RS0019	Pag.	22
RS0033	Pag.	19
RS0039	Pag.	22
RS0040	Pag.	22
RS0049	Pag.	21
RS0053	Pag.	19
RS0069	Pag.	19
RS0085	Pag.	20
RS0086	Pag.	20
RS0087	Pag.	20

RS0088	Pag.	20
RS0089	Pag.	20
RS0090	Pag.	20
RS0091	Pag.	20
RS0092	Pag.	21
RS0094	Pag.	20
RS0100	Pag.	21
RS0101	Pag.	22
RS0103	Pag.	22
RS0105	Pag.	19
RS0107	Pag.	21
RS0108	Pag.	21
RS0120	Pag.	19
RS0131	Pag.	22
RS0132	Pag.	21
RS0220	Pag.	19
RS0253	Pag.	19
RS4123	Pag.	22
RS5006	Pag.	22
RS5808	Pag.	20
RS8817	Pag.	22
RS9040	Pag.	23
RS9200	Pag.	22
RS9501	Pag.	23
RS9540	Pag.	23
RS9810	Pag.	23

RACOR REDUCTOR

RR0129	Pag.	28
RR0132	Pag.	26
RR0135	Pag.	26
RR0136	Pag.	27
RR0137	Pag.	26
RR0138	Pag.	27
RR0139	Pag.	28
RR0144	Pag.	29
RR0146	Pag.	27
RR0147	Pag.	28
RR0229	Pag.	28
RR0230	Pag.	27
RR0231	Pag.	25
RR0232	Pag.	26
RR0233	Pag.	30
RR0234	Pag.	28
RR0235	Pag.	26
RR0335	Pag.	28
RR7045	Pag.	25
RR7046	Pag.	27
RR7047	Pag.	27
RR7049	Pag.	26
RR7125	Pag.	26
RR7127	Pag.	27
RR7300	Pag.	29

ÍNDICE DE REFERENCIAS

RR7301	Pag.	29
RR7304	Pag.	25
RR7383	Pag.	28
RR8100	Pag.	29
RR8102	Pag.	30
RR8105	Pag.	30
RR8108	Pag.	30
RR8113	Pag.	30
RR8114	Pag.	26
RR8118	Pag.	30
RR8120	Pag.	30
RR8122	Pag.	30
RR8128	Pag.	29
RR8129	Pag.	29
RR9050	Pag.	25
RR9221	Pag.	26
RR9243	Pag.	26
RR9310	Pag.	29
RR9312	Pag.	30
RR9350	Pag.	27
RR9470	Pag.	29
RR9471	Pag.	29
RR9472	Pag.	29
RR9670	Pag.	27
RR9671	Pag.	27
RR9680	Pag.	25
RR9681	Pag.	25
RR9682	Pag.	25
RR9683	Pag.	25
RR9880	Pag.	28
RR9891	Pag.	28
RR9892	Pag.	28

RACOR CONECTOR

RC0121	Pag.	31
RC0122	Pag.	32
RC0123	Pag.	32
RC0124	Pag.	31
RC0130	Pag.	32
RC0131	Pag.	32
RC0133	Pag.	31
RC0134	Pag.	31
RC0142	Pag.	31
RC0143	Pag.	31
RC0145	Pag.	32
RC0148	Pag.	32
RC0149	Pag.	32
RC0301	Pag.	31
RC0302	Pag.	31
RC7111	Pag.	32
RC7112	Pag.	32

RACOR EMPALME

RE0150	Pag.	33
RE0151	Pag.	33
RE0152	Pag.	33
RE0153	Pag.	33
RE0154	Pag.	33
RE0155	Pag.	33
RE0156	Pag.	33
RE6860	Pag.	33
RE6862	Pag.	34

RACOR TEE

RT0125	Pag.	35
RT0126	Pag.	35
RT0127	Pag.	35
RT0128	Pag.	36
RT0140	Pag.	35
RT0141	Pag.	35
RT4004	Pag.	36
RT7056	Pag.	35
RT7091	Pag.	35
RT7092	Pag.	36
RT7094	Pag.	36
RT7095	Pag.	35
RT8004	Pag.	36

RACOR PROTECTOR

RT4054	Pag.	37
RT4056	Pag.	37
RT4107	Pag.	37
RT4604	Pag.	37
RT4605	Pag.	37
RT4606	Pag.	37
RT4607	Pag.	37
RT5392	Pag.	38
RT5795	Pag.	37
RT5841	Pag.	38

RACOR ANULADOR

RA0500	Pag.	39
RA5029	Pag.	40
RA7160	Pag.	39
RA7161	Pag.	40
RA7162	Pag.	40
RA7163	Pag.	41
RA7164	Pag.	39
RA7165	Pag.	40
RA7166	Pag.	40
RA7167	Pag.	41
RA8001	Pag.	40
RA8002	Pag.	39
RA8003	Pag.	40
RA9010	Pag.	40

RA9020	Pag.	39
RA9340	Pag.	41
RA9620	Pag.	41
RA9700	Pag.	39
RA9800	Pag.	39
RA9810	Pag.	40
RA9860	Pag.	39
RA9901	Pag.	40

RACOR BANJO

RB4250	Pag.	44
RB4251	Pag.	43
RB4252	Pag.	44
RB4253	Pag.	44
RB4254	Pag.	43
RB4255	Pag.	44
RB4256	Pag.	43
RB4257	Pag.	44
RB4258	Pag.	43
RB4259	Pag.	43
RB8010	Pag.	44
RB8011	Pag.	44
RB8078	Pag.	43
RB8079	Pag.	43
RB8080	Pag.	44
RB8081	Pag.	44
RB9160	Pag.	44
RB9370	Pag.	43
RB9730	Pag.	45

RACOR OJAL

RJ5359	Pag.	47
RJ7060	Pag.	47
RJ7061	Pag.	47
RJ7062	Pag.	48
RJ7063	Pag.	49
RJ7150	Pag.	47
RJ7151	Pag.	47
RJ7152	Pag.	47
RJ7155	Pag.	48
RJ7271	Pag.	49
RJ8001	Pag.	48
RJ8070	Pag.	48
RJ8071	Pag.	48
RJ8074	Pag.	48
RJ8075	Pag.	48
RJ8076	Pag.	48
RJ9111	Pag.	48
RJ9180	Pag.	48
RJ9360	Pag.	47
RJ9650	Pag.	47

KIT DE RACORERÍA

RK0010A	Pag.	51
RK0010B	Pag.	51
RK0010C	Pag.	51
RK0010R	Pag.	51
RK0035E	Pag.	55
RK0040T	Pag.	55
RK0064R	Pag.	54
RK0070A	Pag.	56
RK0070G	Pag.	55
RK0160S	Pag.	53
RK0260M	Pag.	52

HIDROSTOP FRENO

HF8001	Pag.	57
HF8002	Pag.	57
HF8003	Pag.	57
HF8004	Pag.	57
HF8005	Pag.	57

VÁLVULA FRENO

VF5273	Pag.	59
VF9130	Pag.	59
VF9170	Pag.	59
VF9190	Pag.	59
VF9210	Pag.	59
VF9220	Pag.	59
VF9230	Pag.	60
VF9240	Pag.	59
VF9250	Pag.	60
VF9310	Pag.	59

SERVO FRENO

SF4066	Pag.	61
SF4067	Pag.	61
SF5024	Pag.	61
SF5033	Pag.	61

LENTEJA FRENO

LF5430	Pag.	63
LF6205	Pag.	63
LF6206	Pag.	63
LF6208	Pag.	63
LF6210	Pag.	64
LF7244	Pag.	63
LF8006	Pag.	63
LF8007	Pag.	63
LF8008	Pag.	63

GRAPAS FRENO

GF0158	Pag.	66
GF0159	Pag.	66
GF0260	Pag.	66

GF0261	Pag.	66
GF0362	Pag.	66
GF0363	Pag.	66
GF4240	Pag.	66
GF4241	Pag.	67
GF4242	Pag.	66
GF4243	Pag.	67
GF4250	Pag.	65
GF4251	Pag.	66
GF4252	Pag.	66
GF4253	Pag.	67
GF6380	Pag.	65
GF6381	Pag.	65
GF6382	Pag.	65
GF7034	Pag.	65
GF7035	Pag.	65
GF7249	Pag.	65
GF7250	Pag.	65

CIRCLIP FRENO

CF4200	Pag.	69
CF4201	Pag.	70
CF4202	Pag.	69
CF4203	Pag.	69
CF4205	Pag.	70
CF4206	Pag.	70
CF4207	Pag.	70
CF4208	Pag.	70
CF4209	Pag.	71
CF4210	Pag.	69
CF4212	Pag.	69
CF4213	Pag.	70
CF4214	Pag.	71
CF4216	Pag.	70
CF4217	Pag.	71
CF4219	Pag.	71
CF4220	Pag.	69
CF4221	Pag.	71
CF4222	Pag.	70
CF4223	Pag.	69
CF4224	Pag.	71
CF5106	Pag.	70
CF5107	Pag.	70
CF5169	Pag.	69

PIPA FRENO

PF8001	Pag.	74
PF8007	Pag.	74
PF8008	Pag.	73
PF9020	Pag.	73
PF9030	Pag.	73
PF9211	Pag.	74
PF9300	Pag.	73

PF9310	Pag.	73
PF9320	Pag.	73
PF9370	Pag.	74
PF9530	Pag.	73
PF9540	Pag.	73
PF9940	Pag.	74

DEPÓSITO FRENO

DF9040	Pag.	75
DF9041	Pag.	75
DF9050	Pag.	76
DF9051	Pag.	76
DF9060	Pag.	75
DF9061	Pag.	75
DF9080	Pag.	76
DF9081	Pag.	76
DF9320	Pag.	76
DF9321	Pag.	76

ARANDELAS FRENO

AF6009	Pag.	77
AF6014	Pag.	77
AF6015	Pag.	77
AF6016	Pag.	77
AF6017	Pag.	77
AF6021	Pag.	77
AF6024	Pag.	77
AF6027	Pag.	77
AF6031	Pag.	77
AF6061	Pag.	77
AF6064	Pag.	77
AF6065	Pag.	77
AF6066	Pag.	77
AF6067	Pag.	77
AF6071	Pag.	77
AF6074	Pag.	77
AF6077	Pag.	77
AF6081	Pag.	77

MUELLES FRENO

MF4500	Pag.	79
MF4501	Pag.	79
MF4503	Pag.	81
MF4504	Pag.	81
MF4505	Pag.	82
MF4506	Pag.	82
MF4507	Pag.	82
MF4508	Pag.	82
MF4509	Pag.	83
MF4510	Pag.	83
MF4511	Pag.	83
MF4512	Pag.	83
MF4513	Pag.	84

ÍNDICE DE REFERENCIAS

MF4514	Pag.	84
MF4515	Pag.	84
MF4516	Pag.	84
MF4517	Pag.	85
MF4518	Pag.	85
MF4519	Pag.	85
MF4520	Pag.	85
MF4521	Pag.	85
MF4522	Pag.	86
MF4523	Pag.	86
MF4524	Pag.	86
MF4525	Pag.	86
MF4526	Pag.	87
MF4527	Pag.	87
MF4528	Pag.	88
MF4529	Pag.	88

TUBERÍAS FRENO

TF0425D	Pag.	90
TF0610S	Pag.	90
TF0625D	Pag.	90
TF0825D	Pag.	90
TF1010C	Pag.	89
TF1010N	Pag.	89
TF1010S	Pag.	90
TF1210C	Pag.	89
TF3505C	Pag.	89
TF3510C	Pag.	89
TF3510N	Pag.	89
TF3525C	Pag.	89
TF4510C	Pag.	89
TF4705C	Pag.	89
TF4710C	Pag.	89
TF4710H	Pag.	90
TF4710N	Pag.	89
TF4725C	Pag.	89
TF4725H	Pag.	90
TF5005C	Pag.	89
TF5010C	Pag.	89
TF5025C	Pag.	89
TF6005C	Pag.	89
TF6010C	Pag.	89
TF6010H	Pag.	90
TF6010N	Pag.	89
TF6025C	Pag.	89
TF6025H	Pag.	90
TF6305C	Pag.	89
TF6310C	Pag.	89
TF6310H	Pag.	90
TF6310N	Pag.	89
TF6325C	Pag.	89
TF6325H	Pag.	90
TF8010C	Pag.	89

TF8010H	Pag.	90
TF8010N	Pag.	89
TF8025C	Pag.	89

UTILLAJE FRENO

UF0003	Pag.	92
UF0100	Pag.	91
UF0110	Pag.	92
UF0130	Pag.	92
UF0250	Pag.	91
UF0312	Pag.	93
UF0346	Pag.	93
UF0350	Pag.	92
UF0410	Pag.	93
UF0414	Pag.	91
UF0601	Pag.	93
UF4123	Pag.	103
UF5001	Pag.	95
UF5006	Pag.	104
UF5012	Pag.	100
UF5014	Pag.	99
UF5015	Pag.	100
UF5018	Pag.	94
UF5031	Pag.	103
UF5048	Pag.	103
UF5087	Pag.	99
UF5090	Pag.	101
UF5102	Pag.	104
UF5114	Pag.	102
UF5115	Pag.	101
UF5124	Pag.	100
UF5126	Pag.	100
UF5135	Pag.	94
UF5152	Pag.	104
UF5154	Pag.	99
UF5166	Pag.	98
UF5172	Pag.	101
UF5184	Pag.	102
UF5308	Pag.	95
UF5315	Pag.	99
UF5320	Pag.	101
UF5322	Pag.	97
UF5339	Pag.	92
UF5347	Pag.	102
UF5392	Pag.	98
UF5413	Pag.	98
UF5426	Pag.	97
UF5432	Pag.	95
UF5513	Pag.	103
UF5516	Pag.	94
UF5519	Pag.	100
UF5533	Pag.	103
UF5535	Pag.	102

UF5609	Pag.	101
UF5622	Pag.	93
UF5633	Pag.	94
UF5642	Pag.	95
UF5680	Pag.	104
UF5689	Pag.	98
UF5697	Pag.	97
UF5707	Pag.	96
UF5719	Pag.	96
UF5738	Pag.	102
UF5760	Pag.	94
UF5798	Pag.	97
UF5817	Pag.	95
UF5818	Pag.	96
UF5831	Pag.	96
UF5833	Pag.	96
UF5918	Pag.	91
UF5964	Pag.	98
UF5981	Pag.	97
UF5999	Pag.	99

